



Tomahawk llc.

L I V E • T R A P

Dependable. Tough. **Tomahawk.**

PROUDLY
MADE IN THE USA

**MANUFACTURED AND ASSEMBLED
BY THE HARDWORKING EMPLOYEES OF
TOMAHAWK LIVE TRAP • HAZELHURST, WISCONSIN**





Tomahawk llc.
L I V E ■ T R A P

The Tomahawk Live Trap team is committed to providing you with the finest animal traps, cages, and animal handling equipment available. Our mission is to exceed our customer's expectations by providing them with the highest quality humane animal control products available. We deliver our products as timely as possible, usually shipping within one business day.

Many of you have approached us with great ideas about new and improved products. We often build custom traps, cages and other animal handling products for our customers. Thank you for these opportunities and the trust you have in us. We genuinely enjoy working with you our valued customers to develop new products and improve existing ones.

We proudly manufacture our products in the USA at our 40,000 square foot facility in Northern Wisconsin. Our team takes pride in the quality of their work and we back all of our products with a one-year warranty against factory defects.

My wife Jenny and I attend many trade conferences each year all around our great country and we genuinely enjoyed visiting with each of you. If you should see us at one of these conferences in the future, please stop by and say hello or give us a call at 800-272-8727 to share your thoughts. We can also be reached via email at greg@livetraps.com or jenny@livetraps.com. The team at Tomahawk Live Trap greatly appreciates you, our valued customers, for your continued support.



WE SINCERELY WANT TO SAY

Thank You

*Greg Smith and
Jenny Smith*



PAGE 4



PAGE 9



PAGE 13



PAGE 18

Owner Letter	2	Dog Kennel Crates	26	Gopher/Mole Tunnel Trap	44
TOC	3	Trap Dividers	27	Nest-able Bobcat Slamper Trap	45
The Tomahawk Original Series Traps	4	Trap Flag & Trap Flag Light	27	Collarum Humane Snares	45
Rigid Traps with One Trap Door	5	Trap Wraps and Covers	28	Small Bird Traps	46
Rigid Traps with One Trap Door and Easy Release Door	6	Plastic Trap Tags	29	Chicken Traps	46
Rigid Traps with Two Trap Doors	7	Customized Trap ID Tag and Pet ID Tags	29	Pigeon Traps	47
Flush Mount Traps with One Trap Door	7	Wheel Kits	30	Goshawk / Bird of Prey Trap	48
Flush Mount Traps with One Trap Door and Easy Release Door	7	Cage Cups	30	The Intimidator Avian Deterrent	48
Collapsible Traps with One Trap Door	8	Directional Nose Cones	31	Beaver Traps	49
Collapsible Traps with Two Trap Doors	8	Flush Mount Nose Cones	31	Fish Traps	50
The Tomahawk Professional Series Traps	9	Multi-Purpose Converters	31	Fish Live Boxes	50
Pro Series Traps with One Trap Door	10	Mounting Cones	32	Crawfish, Crab and Lobster Traps	51
Pro Series Traps with One Trap Door and Easy Release Door	10	Inside Corner Cones	32	Tomahawk Colony Traps	52
Three Chamber Professional Transfer Cage	10	Roff Vent Funnels	32	Turtle Traps	53
Pro Series Flush Mount Traps	11	Alkerton Raccoon Nose Cone	33	Bullfrog Traps	53
Pro Series Double Door Traps	12	Alkerton Collapsible Nose Cone	33	Snake And Lizard Traps	54
Multi-Purpose Traps	12	Trap Docks	33	Tomahawk Standard Snake Tongs	55
NWCOA Roof/Attic Trap	12	Excluders	34	Tomahawk Deluxe Snake Tongs	56
Comstock Traps	13	Squirrel Packs / Squirrel Removal Systems	35	Tomahawk Extreme Grip Snake Tongs	57
Comstock 9 x 11 Single Door	14	Deluxe Squirrel Packs / Squirrel Removal Systems	35	Ton Jones Snake Tongs	58
Comstock 9 x 11 Single Door with Rear Bait Door	14	Repeating Traps for Squirrel Packs	36	Snake Tong Accessories	59
Comstock 9 x 11 Single Door with Rear Release Sliding Door	14	Soffit Cones	36	Tomahawk Snake Hooks	60
Comstock 9 x 11 Double Door	15	Corner Cones for inside corners	36	Ton Jones Stump Rippers, Snake Pinners & Hooks	61
Comstock 9 x 11 Double Door with One Flush Mount Door	15	Bat Cones	37	Dura-Fex Animal Nets & Y-Poles	62
Comstock 9 x 11 Multi-Purpose Trap	15	Squirrel Cone Excluders	37	Versa Nets for Cats	63
Comstock Beaver Trap	16	Ridge Guard	37	Hammock Nets	63
Comstock 12 x 12 Traps	16	Critter Picker	37	Freeman Cage Nets	63
Comstock Chimney Trap	16	Chimney Covers	38	Animal Nets	64
Comstock Swing Panel Traps	17	Roof Vent Covers	38	Throw Nets	65
Comstock Accessories	17	Soffit and Foundation Covers	38	EZ Nabbers	65
Tomahawk Feral Cat Series Traps	18	Defender Vent Covers	39	Snappy Snares, Leads & Leashes	66
Feral Cat Series Traps	19	Xcluder Rodent Prevention Products	39	Animal Control Poles	67
Collapsible Drop Traps	19	Multi-Catch Repeating Traps	40	Standard Animal Graspers	68
Feral Cat Trap Kits	20	Single Set Repeating Traps (Simple Traps)	41	Heavy Duty Animal Graspers	68
Tomahawk Feral Cat Accessories	21-22	Ferret Trap	41	Syringe Poles and Jab Sticks	69
Tomahawk Feral Cat Dens/Carriers	23-24	Ground Hugger Multiple Catch Traps	41	Animal Gloves	70-71
Transfer Cages	24	Sherman Traps	42	Baits	72-73
Restraint Modules & Squeeze Cages	25	Enclosed Traps	43	Ogena Solutions Cleaning Products	74
		Skunk Traps	43	Custom Traps, Roll Wire, and Replacement Parts	75
		Tomahawk Chimney Trap	44		
		Koonce Door Set Raccoon Trap	44		





"I like coming into work not knowing what I'll be making that day. We have such a large variety of products that we make on a daily basis. The variety and quality of our products shows we listen and take care of our customers."

Casey
Specialty Traps &
Custom Products Specialist

The Tomahawk Original Series Traps

Tomahawk Original Series traps are the strongest, most reliable, and most durable traps available. These traps are constructed with galvanized wire mesh frames, and have steel reinforcing rods welded to the frame for added strength.

The entire trap is galvanized to provide maximum protection against rust and corrosion. Our traps are made in the USA at our facility in Wisconsin. Backed with a one-year factory warranty, each trap is quality inspected and tested before it is shipped to you, our valued customer.

PRODUCT HIGHLIGHTS

- Spring loaded trap doors quickly snap into place preventing animals from backing out when the trap is sprung
- Locking trap doors prevent animals from escaping, even if the trap is turned over or flipped completely upside down
- Tighter wire mesh pattern around bait areas prevent animals from reaching into the trap and stealing bait from the outside
- Easy adjusting trigger system allows for light or heavy trap sets
- Brass roller and "wound-around" trigger assures nearly 100% capture rate with virtually no misfires
- Hand guards under trap handles on most models protect handlers against animal scratches
- A wide variety of trap sizes in several categories to choose from. Catch small rodents on up to large dogs

PRO
MADE IN THE USA

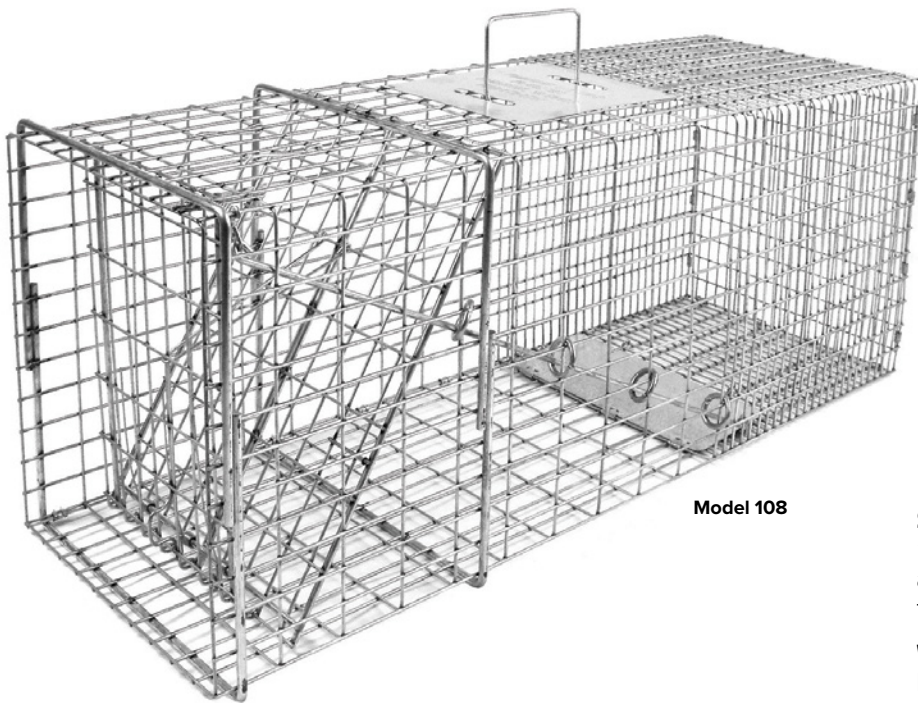

Model 108

the Tomahawk Original Series Traps Include:

- Spring loaded trap doors
- Locking trap doors
- Strategic mesh patterns
- Sure-fire trigger
- Adjustable trigger

Superior strength - Tomahawk Original Series Traps are the most reliable traps on the market. They are built with heavy duty materials and backed by a one year manufacturers warranty. Each trap is hand tested and inspected for quality.

Very affordable - These traps have a single trap door and do not have a back door. This means animals must be released through the same door from which they entered the trap. The single trap door design makes this category more affordable than most of our other trap categories.

Original series - Rigid Traps with One Trap Door

Model	SUGGESTED TARGET ANIMAL SIZE	L - W - H	Construction	Wt	Price	6+
102	Chipmunks, Gophers, Rats and Similar Sizes	16 x 5 x 5	½ x 1 - 16 gauge	2 lbs	\$31.25	\$28.13
102XL	Chipmunks, Gophers, Rats and Similar Size	18 x 5 x 5	½ x 1 - 16 gauge	2 lbs	\$31.25	\$28.13
103	Squirrels, Muskrats and Similar Sizes	19 x 6 x 6	1 x 1 - 14 gauge	3 lbs	\$33.40	\$30.06
103.5	Chipmunks, Gophers, Rats and Similar Sizes	18 x 6 x 6	½ x 1 - 16 gauge	3 lbs	\$35.50	\$31.95
104.5	Skunks, Opossum, Prairie Dogs and Similar Sizes	20 x 7 x 7	1 x 1 - 14 gauge	3 lbs	\$39.00	\$35.10
105	Extra Long for Skunks, Opossum and Similar Sizes	24 x 7 x 7	1 x 1 - 14 gauge	3 lbs	\$40.30	\$36.27
105.2	Sheet Metal Covered Trap for Skunk	24 x 7 x 7	1 x 1 - 14 gauge	6 lbs	\$71.90	\$64.71
106	Cats, Rabbits, Opossum and Similar Sizes	26 x 9 x 9	1 x 1 - 14 gauge	6 lbs	\$54.60	\$49.14
106.3	Cats, Rabbits, Opossum and Similar Sizes	30 x 9 x 9	1 x 1 - 14 gauge	6 lbs	\$59.10	\$53.19
1010	Raccoon, Feral Cats, Badgers, Woodchucks and Similar Sizes	32 x 10 x 10	1 x 2 - 12 gauge	10 lbs	\$66.25	\$59.63
108	Raccoon, Feral Cats, Badgers, Woodchucks and Similar Sizes	32 x 10 x 12	1 x 2 - 12 gauge	11 lbs	\$73.95	\$66.56
108.1	Same as 108 except with 1 x 1 - 12 gauge wire	32 x 10 x 12	1 x 1 - 12 gauge	13 lbs	\$79.00	\$71.10
108.5	Large Raccoon, Large Woodchucks and Similar Sizes	36 x 12 x 12	1 x 2 - 12 gauge	14 lbs	\$95.15	\$85.64
109.5	Bobcats, Fox and Similar Sizes	42 x 15 x 20	1 x 2 - 12 gauge	22 lbs	\$158.75	\$142.88
110A	Small Dogs, Fox and Similar Sizes	48 x 20 x 26	1 x 2 - 12 gauge	32 lbs	\$313.25	\$281.93
110B	Medium Dogs, Coyote and Similar Sizes	60 x 20 x 26	1 x 2 - 12 gauge	35 lbs	\$323.85	\$291.47
110C	Large Dogs, Coyote and Similar Sizes	72 x 20 x 26	1 x 2 - 12 gauge	40 lbs	\$334.45	\$301.01

the Tomahawk Original Series Traps Include:

- Spring loaded trap doors
- Locking trap doors
- Strategic mesh patterns
- Sure-fire trigger
- Adjustable trigger

Easy animal release - Easy release door provides the safest and easiest way to release trapped animals.

Easy animal transfer - Easy release door allows captured animals to be safely and easily transferred to holding or transfer cages. We offer a line of transfer cages that match up perfectly with these traps. This allows you to keep your traps in the field by transferring animals from your traps into transfer cages.

Easy trap baiting - Baiting is much easier when done from the back of the trap with the easy release door removed. You no longer have to reach through the front of the trap and risk setting it off.

Simple to operate - Unsnap the latch which holds the easy release door in place, and remove it by lifting up on the attached handle.

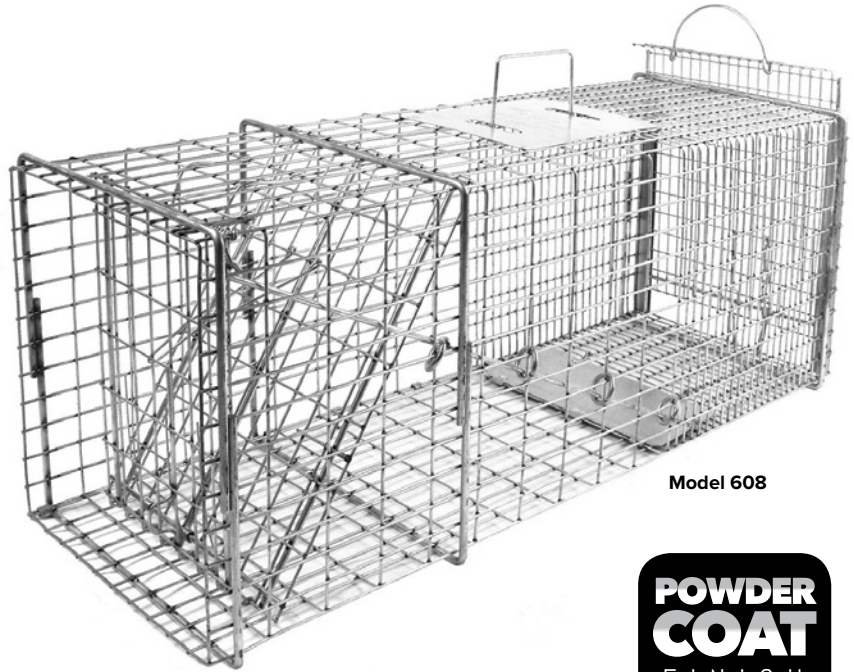

Model 608

POWDER COAT FINISH
Available for an additional 15% Black only

Original Series - Rigid Traps with One Trap Door and Easy Release Door

Model	Suggested Target Animal Size	L - W - H	Construction	Wt	Price	6+
602	Chipmunks, Gophers, Rats and Similar Sizes	16 x 5 x 5	½ x 1 - 16 gauge	2 lbs	\$36.60	\$32.94
602XL	Chipmunks, Gophers, Rats and Similar Sizes	18 x 5 x 5	½ x 1 - 16 gauge	2 lbs.	\$36.60	\$32.94
603	Squirrels, Muskrats and Similar Sizes	19 x 6 x 6	1 x 1 - 14 gauge	3 lbs	\$37.90	\$34.11
603.5	Chipmunks, Gophers, Rats, and Similar Sizes	18 x 6 x 6	½ x 1 - 16 gauge	3 lbs	\$40.00	\$36.00
604.5	Skunks, Opossum, Prairie Dogs and Similar Sizes	20 x 7 x 7	1 x 1 - 14 gauge	3 lbs	\$44.00	\$39.60
605	Skunks, Opossum, Prairie Dogs and Similar Sizes	24 x 7 x 7	1 x 1 - 14 gauge	3 lbs	\$45.30	\$40.77
605.2	Sheet Metal Covered Trap for Skunks	24 x 7 x 7	1 x 1 - 14 gauge	7lbs	\$79.50	\$71.55
606	Cats, Rabbits, Opossum and Similar Sizes	26 x 9 x 9	1 x 1 - 14 gauge	7 lbs	\$63.35	\$57.02
606.3	Cats, Rabbits, Opossum and Similar Sizes	30 x 9 x 9	1 x 1 - 14 gauge	7 lbs	\$65.70	\$59.13
6010	Raccoon, Feral Cats, Badgers, Woodchucks and Similar Sizes	32 x 10 x 10	1 x 1 - 12 gauge	11 lbs	\$76.85	\$69.17
608	Raccoon, Feral Cats, Badgers, Woodchucks and Similar Sizes	32 x 10 x 12	1 x 2 - 12 gauge	12 lbs	\$84.30	\$75.87
608.1	Same as 608 Except with 1 x 1 Mesh	32 x 10 x 12	1 x 1 - 12 gauge	13 lbs	\$89.60	\$80.64
608.5	Large Raccoon, Large Woodchucks and Similar Sizes	36 x 12 x 12	1 x 2 - 12 gauge	15 lbs	\$105.75	\$95.18
609	Large Raccoon, Large Woodchucks and Similar Sizes	36 x 12 x 14	1 x 1 - 14 gauge	14 lbs	\$105.75	\$95.18
609.5	Bobcats, Fox and Similar Sizes	42 x 15 x 20	1 x 2 - 12 gauge	25 lbs	\$178.60	\$160.74
610A	Small Dogs, Fox and Similar Sizes	48 x 20 x 26	1 x 2 - 12 gauge	37 lbs	\$334.45	\$301.01
610B	Medium Dogs, Coyote and Similar Sizes	60 x 20 x 26	1 x 2 - 12 gauge	40 lbs	\$345.00	\$310.50
610C	Large Dogs, Coyote and Similar Sizes	72 x 20 x 26	1 x 2 - 12 gauge	43 lbs	\$355.65	\$320.09

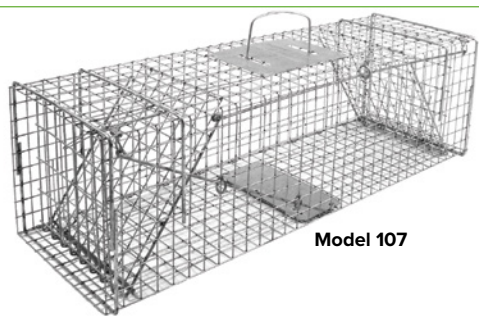

Model 107

Calms wary animals - Trap doors at both ends allow animals to see through the trap without obstruction and enter with confidence.

Allows entry from either end - Trap doors at both ends allow animals to enter the trap from either end, increasing your chances of success.

SET AS SINGLE OR DOUBLE DOOR - Traps with two trap doors are more versatile because they can be set with only the front door as a baited trap or set both trap doors to use as a bait-less runway trap.

Original series - Rigid Traps with Two Trap Doors

Model	Suggested Target Animal Size	L - W - H	Construction	Wt	Price	6+
104	Squirrels, Muskrats and Similar Sizes	24 x 6 x 6	1 x 1 - 14 gauge	3 lbs	\$45.05	\$40.55
104.1	Squirrels, Muskrats and Similar Sizes	24 x 6 x 6	½ x 1 - 16 gauge	4 lbs	\$47.15	\$42.44
105.5	Skunks, Opossum, Prairie Dogs and Similar Sizes	24 x 7 x 7	1 x 1 - 14 gauge	4 lbs	\$54.85	\$49.37
107	Cats, Rabbits, Opossum and Similar Sizes	32 x 9 x 9	1 x 1 - 14 gauge	7 lbs	\$74.20	\$66.78
1010DD	Raccoon, Cats, Woodchuck and Similar Sizes	36 x 10 x 10	1 x 1 - 12 gauge	13 lbs	\$90.10	\$81.09
108.6	Raccoon, Feral Cats, Woodchuck and Similar Sizes	36 x 10 x 12	1 x 1 - 12 gauge	14 lbs	\$100.15	\$90.14
108.7	Armadillos, Otters, Large Raccoon and Similar Sizes	48 x 10 x 12	1 x 2 - 12 gauge	17 lbs	\$143.10	\$128.79
109	Fox, Bobcats, Jackrabbits and Similar Sizes	42 x 15 x 15	1 x 2 - 12 gauge	21 lbs	\$148.40	\$133.56

Positive set - Allows for the trap to be flush mounted against den openings when the door is open. This is called a "positive set" because the animal must enter the trap when exiting its den.

Versatile - Flush mount traps can also be used as traditional bait and scent sets as well as flush mount positive sets.



Flush When Set

Original series - Flush Mount Traps with One Trap Door

Model	Suggested Target Animal Size	L - W - H	Construction	Wt	Price	6+
102F	Chipmunks, Gophers, Rats and Similar Sizes	18 x 5 x 5	½ x 1 - 16 gauge	3 lbs	\$34.40	\$30.96
103F	Squirrels, Muskrats and Similar Sizes	20 x 6 x 6	1 x 1 - 14 gauge	4 lbs	\$37.60	\$33.84
103.5F	Squirrels, Muskrats and Similar Sizes	20 x 6 x 6	½ x 1 - 16 gauge	4 lbs	\$39.75	\$35.78
105F	Skunks, Opossum, Prairie Dogs and Similar Sizes	26 x 7 x 7	1 x 1 - 14 gauge	5 lbs	\$44.00	\$39.60
106F	Cats, Rabbits, Opossum and Similar Sizes	30 x 9 x 9	1 x 1 - 14 gauge	8 lbs	\$59.90	\$53.91
1010F	Raccoon, Woodchucks, Feral Cats and Similar Sizes	36 x 10 x 10	1 x 2 - 12 gauge	11 lbs	\$74.20	\$66.78
108F	Raccoon, Woodchucks, Feral Cats and Similar Sizes	36 x 10 x 12	1 x 2 - 12 gauge	13 lbs	\$80.00	\$72.00

Original series - Flush Mount Traps with One Trap Door and Easy Release Door

Model	Suggested Target Animal Size	L - W - H	Construction	Wt	Price	6+
602F	Chipmunks, Gophers, Rats, and Similar Sizes	18 x 5 x 5	½ x 1 - 16 gauge	3 lbs	\$39.75	\$35.78
603F	Squirrels, Muskrats and Similar Sizes	20 x 6 x 6	1 x 1 - 14 gauge	4 lbs	\$42.95	\$38.66
603.5F	Squirrels, Muskrats and Similar Sizes	20 x 6 x 6	½ x 1 - 16 gauge	4 lbs	\$45.05	\$40.55
605F	Skunks, Opossum, Prairie Dogs and Similar Sizes	26 x 7 x 7	1 x 1 - 14 gauge	5 lbs	\$49.55	\$44.60
606F	Cats, Rabbits, Opossum and Similar Sizes	30 x 9 x 9	1 x 1 - 14 gauge	8 lbs	\$66.80	\$60.12
6010F	Raccoon, Groundhogs, Cats, Badgers and Similar Sizes	36 x 10 x 10	1 x 2 - 12 gauge	12 lbs	\$83.75	\$75.38
608F	Raccoon, Woodchucks, Feral Cats and Similar Sizes	36 x 10 x 12	1 x 2 - 12 gauge	13 lbs	\$90.90	\$81.81

the **Tomahawk**
Original
Series Traps
Include:

- Spring loaded trap doors
- Locking trap doors
- Strategic mesh patterns
- Sure-fire trigger
- Adjustable trigger

Collapsible Traps

Minimal storage space required - Folds flat when not in use and take about 1/10th the storage space as rigid traps.

Simple to fold and unfold - Our Collapsible Traps fold flat for storage and set up for deployment in seconds with no tools required.

No assembly required - Collapsible traps come completely assembled.

Two Trap Doors (All of the above features and more...)

Calms wary animals - Trap doors at both ends allow animals to see through the trap without obstruction and enter with confidence.

Allows entry from either end - Trap doors at both ends allow animals to enter the trap from either end, increasing your chances of success.

Two locking trap doors - When an animal sets off the trap by stepping on the trip pan, both spring loaded doors instantly snap shut and lock into place, making escape virtually impossible.

Set as Single Or Double Door - Traps with two trap doors are more versatile because they can be set with only the front door as a baited trap or set both trap doors to use as a baitless runway trap.

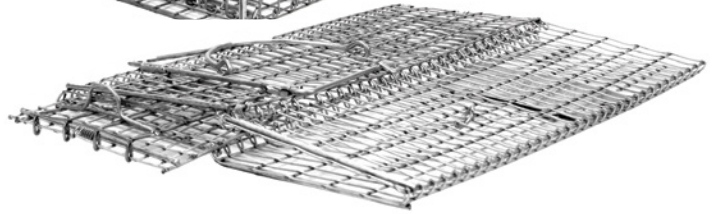
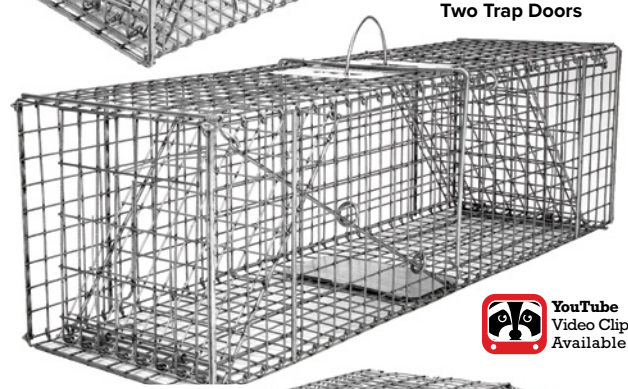
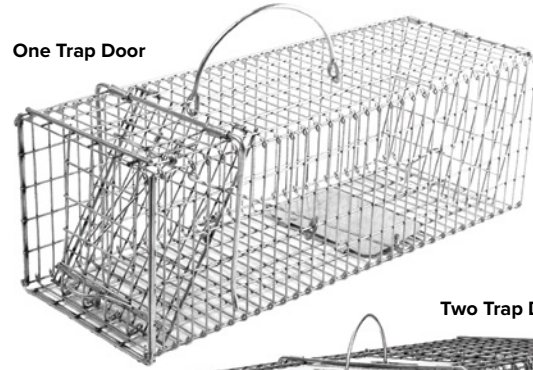

Original Series - Collapsible Traps with One Trap Door

Model	Suggested Target Animal Size	L - W - H	Construction	Wt	Price	6+
201	Chipmunks, Gophers, Rats and Similar Sizes	16 x 5 x 5	1/2 x 1 - 16 gauge	2 lbs	\$40.15	\$36.14
202	Squirrels, Muskrats and Similar Sizes	19 x 6 x 6	1 x 1 - 14 gauge	3 lbs	\$42.15	\$37.94
202.5	Chipmunks, Gophers, Rats, Squirrels and Similar Sizes	19 x 6 x 6	1/2 x 1 - 16 gauge	3 lbs	\$44.50	\$40.05
204	Skunks, Opossum, Prairie Dogs and Similar Sizes	20 x 7 x 7	1 x 1 - 14 gauge	4 lbs	\$50.35	\$45.32
205	Cats, Rabbits, Opossum and Similar Sizes	26 x 9 x 9	1 x 1 - 14 gauge	6 lbs	\$70.50	\$63.45
207	Raccoon, Cats, Rabbits, Woodchucks and Similar Sizes	32 x 10 x 12	1 x 1 - 12 gauge	10 lbs	\$102.90	\$92.61
207.5	Large Raccoon, Large Woodchucks and Similar Sizes	36 x 12 x 12	1 x 1 - 12 gauge	13 lbs	\$139.00	\$125.10
209.5	Bobcat, Fox and Similar Sizes	42 x 15 x 20	1 x 2 - 12 gauge	22 lbs	\$221.65	\$199.49
210A	Small Dogs, Fox and Similar Sizes (with Release Door)	48 x 20 x 26	1 x 1 - 12 gauge	47 lbs	\$335.90	\$302.31
210B	Medium Dogs, Coyote and Similar Sizes (with Release Door)	60 x 20 x 26	1 x 1 - 12 gauge	55 lbs	\$354.80	\$319.32
210C	Large Dogs, Coyote and Similar Sizes (with Release Door)	72 x 20 x 26	1 x 1 - 12 gauge	62 lbs	\$365.20	\$328.68

Original series - Collapsible Traps with Two Trap Doors

Model	Suggested Target Animal Size	L - W - H	Construction	Wt	Price	6+
200	Chipmunks, Rats, Gophers and Similar Sizes	16 x 5 x 5	1/2 x 1 - 16 gauge	3 lbs	\$49.80	\$44.82
203	Squirrels, Muskrats and Similar Sizes	24 x 6 x 6	1 x 1 - 14 gauge	4 lbs	\$52.75	\$47.48
203.5	Chipmunks, Gophers, Rats, Squirrels and Similar Sizes	24 x 6 x 6	1/2 x 1 - 16 gauge	4 lbs	\$54.85	\$49.37
206	Cats, Rabbits, Opossum and Similar Sizes	32 x 9 x 9	1 x 1 - 14 gauge	8 lbs	\$92.75	\$83.48
206.5	Raccoon, Cats, Rabbits, Woodchucks and Similar Sizes	40 x 10 x 10	1 x 2 - 12 gauge	13 lbs	\$105.45	\$94.91
207.3	Raccoon, Cats, Rabbits, Woodchucks and Similar Sizes	36 x 10 x 12	1 x 1 - 12 gauge	15 lbs	\$132.50	\$119.25
208	Bobcats, Fox, and Similar Sizes	42 x 15 x 15	1 x 2 - 12 gauge	18 lbs	\$204.35	\$183.92



"The people that come through the doors here each day are not just my coworkers. They are like family. It's a family I'm proud to be a part of."

Matt
Quality Control Professional

The Tomahawk Professional Series Traps

Tomahawk Professional Series Live Traps are the strongest, most durable, and effective traps available. These traps surpass even our renowned "Original Series" traps when it comes to toughness and durability.

They feature a very strong frame, heavy duty components, more powerful trap door springs, "critter proof" trip pan protection system and tighter mesh throughout the trap.

Tighter mesh patterns prevent animals from reaching in from the outside to steal bait. It also prevents animals from reaching out and damaging property while trapped.

Critter Proof pan guards are installed on all 9 x 9 and larger trap models to prevent animal damage. This means no more wasted time flattening bent trip pans.

Simply put, these are the best of the best and are built to withstand years of daily use. They are manufactured in the USA at our facility in Wisconsin and backed with a one-year warranty against defect. Each trap is inspected and tested before it is shipped to you, our valued customer.

PRODUCT HIGHLIGHTS

- Powerful spring loaded, locking trap doors
- Tight mesh throughout the trap
- Heavy duty components and frame
- Critter Proof pan protection on all 9 x 9 and larger traps
- Many sizes and styles for any situation
- Add mounting loops for \$5.00
- Add a sheet metal bait area cover for \$10.00
- Add powder coating for an additional 15%

the Tomahawk Professional Series Traps Include:

- 1/4" Steel Rod Frame
- Trip Pan Protection System
- Tight mesh patterns
- Adjustable trigger
- Powerful trap door springs.

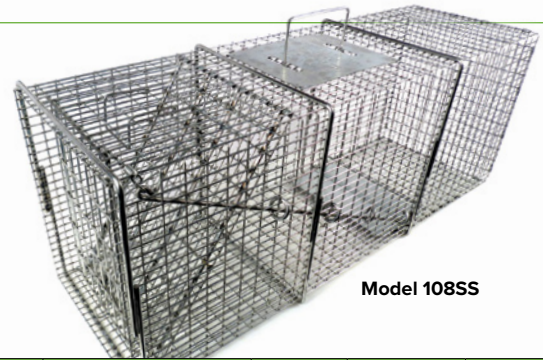

Model 108SS

Professional Series Traps with One Trap Door

Model	Suggested Target Animal Size	L - W - H	Construction	Wt	Price	6+
101SS	Chipmunks, Gophers, Rats and Similar Sizes	18 x 5 x 5	1/2 x 1/2 - 16 gauge	2 lbs	\$35.00	\$31.50
102SS	Chipmunks, Gophers, Rats and Similar Sizes	19 x 5 x 5	1/2 x 1 - 14 gauge	2 lbs	\$38.15	\$34.34
103SS	Squirrels, Muskrats and Similar Sizes	19 x 6 x 6	1/2 x 1 - 14 gauge	3 lbs	\$41.35	\$37.22
105SS	Skunks, Opossum, Prairie Dogs and Similar Sizes	24 x 7 x 7	1/2 x 1 - 14 gauge	5 lbs	\$51.15	\$46.04
106SS	Cats, Rabbits, Opossum and Similar Sizes	26 x 9 x 9	1/2 x 1 - 14 gauge	8 lbs	\$68.90	\$62.01
1010SS	Raccoon, Cats, Opossum, Groundhog and Similar Sizes	30 x 10 x 10	1/2 x 1 - 14 gauge	10 lbs	\$79.50	\$71.55
108SS	Raccoon, Cats, Badgers, Groundhogs and Similar Sizes	32 x 10 x 12	1/2 x 1 - 14 gauge	12 lbs	\$90.10	\$81.09
109SS	Extra Large - Raccoon and Groundhogs	36 x 12 x 12	1/2 x 1 - 14 gauge	16 lbs	\$109.70	\$98.73

Easy animal release - Easy release door provides the safest and easiest way to release trapped animals.

Easy trap baiting - Baiting is much easier when done from the back of the trap with the easy release door removed. You no longer have to reach through the front of the trap and risk setting it off.

Simple to operate - Unsnap the latch which holds the easy release door in place, and remove it by lifting up on the attached handle.



Model 608SS

Professional Series Traps with Easy Release Door

Model	Suggested Target Animal Size	L - W - H	Construction	Wt	Price	6+
602SS	Chipmunks, Gophers, Rats and Similar Sizes	19 x 5 x 5	1/2 x 1 - 14 gauge	3 lbs	\$44.80	\$40.32
603SS	Squirrels, Muskrats and Similar Sizes	19 x 6 x 6	1/2 x 1 - 14 gauge	3 lbs	\$47.95	\$43.16
605SS	Skunks, Opossum, Prairie Dogs, Similar Sizes	24 x 7 x 7	1/2 x 1 - 14 gauge	6 lbs	\$55.65	\$50.09
606SS	Cats, Rabbits, Opossum and Similar Sizes	26 x 9 x 9	1/2 x 1 - 14 gauge	8 lbs	\$73.95	\$66.56
6010SS	Raccoon, Groundhog and Badgers and Similar Sizes	30 x 10 x 10	1/2 x 1 - 14 gauge	11 lbs	\$90.10	\$81.09
608SS	Raccoon, Feral Cats, Woodchucks and Similar Sizes	32 x 10 x 12	1/2 x 1 - 14 gauge	12 lbs	\$100.70	\$90.63
609SS	Extra Large - Raccoon and Groundhogs	36 x 12 x 12	1/2 x 1 - 14 gauge	16 lbs	\$121.90	\$109.71



Three Chamber Professional Transfer Cage

Model	Description	L - W - H	Construction	Wt	Price	6+
333	Three Chamber Transfer Cage	36 x 10 x 12	1/2 x 1 - 14 gauge	13 lbs.	\$105.45	\$94.91

the Tomahawk Professional Series Traps Include:

- 1/4" Steel Rod Frame
- Trip Pan Protection System
- Tight mesh patterns
- Adjustable trigger
- Powerful trap door springs.

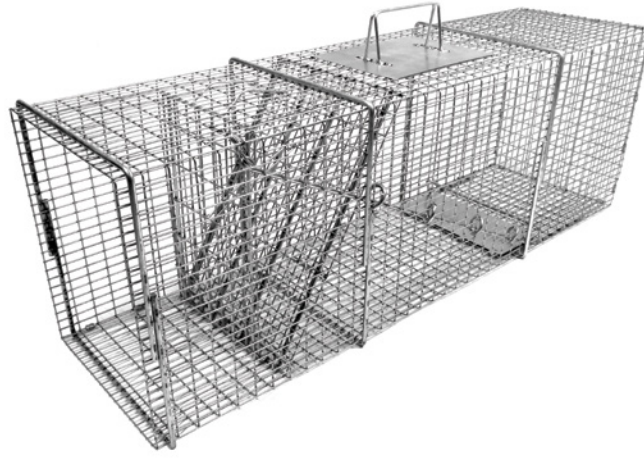

Flush mount door - Trap door does not extend past the end of the trap when set allowing for positive set placement against structures.

Professional Series Traps with Flush Mount Trap Door

Model	Suggested Target Animal Size	L - W - H	Construction	Wt	Price	6+
102SS-F	Chipmunks, Gophers, Rats, Similar Sizes	19 x 5 x 5	1/2 x 1 - 14 gauge	3 lbs	\$40.30	\$36.27
103SS-F	Squirrels, Muskrats, Similar Sizes	21 x 6 x 6	1/2 x 1 - 14 gauge	4 lbs	\$44.50	\$40.05
105SS-F	Skunk, Opossum, Prairie Dogs, Similar Sizes	26 x 7 x 7	1/2 x 1 - 14 gauge	5 lbs	\$55.40	\$49.86
106SS-F	Cats, Rabbits, and Similar Size Animals	30 x 9 x 9	1/2 x 1 - 14 gauge	8 lbs	\$73.15	\$65.84
1010SS-F	Raccoon, Feral Cats, Badgers, Groundhogs and Similar Sizes	32 x 10 x 10	1/2 x 1 - 14 gauge	11 lbs	\$90.10	\$81.09
108.2SS	Raccoon, Feral Cats, Badgers, Groundhogs and Similar Sizes	36 x 10 x 12	1/2 x 1 - 14 gauge	13 lbs	\$100.70	\$90.63
109SS-F	Extra Large - Raccoon, Groundhogs	42 x 12 x 12	1/2 x 1 - 14 gauge	16 lbs	\$119.25	\$107.33

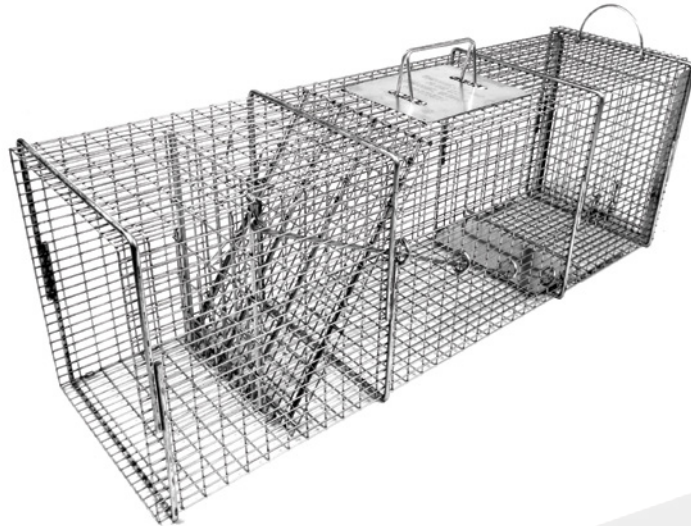

Flush mount door - Trap door does not extend past the end of the trap when set allowing for positive set placement against structures.

Easy trap baiting - Rear access door makes baiting your trap and removal of animals easy.

Professional Series Traps with Flush Mount Trap Door and Easy Release Door

Model	Suggested Target Animal Size	L - W - H	Construction	Wt	Price	6+
602SS-F	Chipmunks, Gophers, Rats, Similar Sizes	19 x 5 x 5	1/2 x 1 - 14 gauge	3 lbs	\$46.65	\$41.99
603SS-F	Squirrels, Muskrats, Similar Sizes	21 x 6 x 6	1/2 x 1 - 14 gauge	4 lbs	\$50.90	\$45.81
605SS-F	Skunk, Opossum, Prairie Dogs, Similar Sizes	26 x 7 x 7	1/2 x 1 - 14 gauge	6 lbs	\$59.35	\$53.42
606SS-F	Cats, Rabbits, and Similar Size Animals	30 x 9 x 9	1/2 x 1 - 14 gauge	8 lbs	\$79.50	\$71.55
6010SS-F	Raccoon, Feral Cats, Badgers, Groundhogs and Similar Sizes	32 x 10 x 10	1/2 x 1 - 14 gauge	12 lbs	\$100.70	\$90.63
608.2SS	Raccoon, Feral Cats, Badgers, Groundhogs and Similar Sizes	36 x 10 x 12	1/2 x 1 - 14 gauge	13 lbs	\$111.30	\$100.17
609SS-F	Extra Large - Raccoon, Groundhogs	42 x 12 x 12	1/2 x 1 - 14 gauge	16 lbs	\$132.50	\$119.25

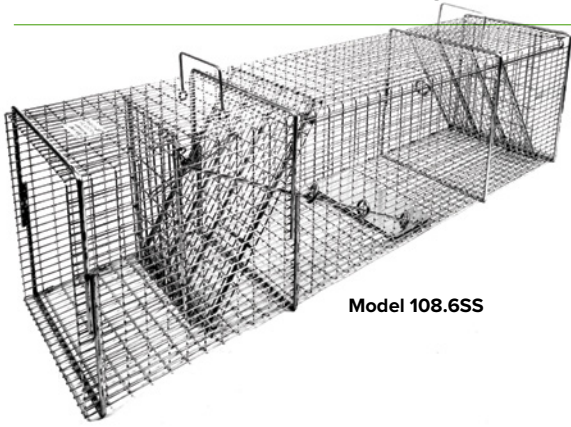

Model 108.6SS

Calms wary animals - Trap doors at both ends allow animals to see through the trap without obstruction and enter with confidence.

Allows entry from either end - Trap doors at both ends allow animals to enter the trap from either end, increasing your chances of success.

Two locking trap doors - When an animal sets off the trap by stepping on the trip pan, both spring loaded doors instantly snap shut and lock into place, making escape virtually impossible.

One Flush Mount Door - Allows the trap to be flush mounted against den openings when the door is open and the trap is armed. This makes it a "positive set" trap because the animal must enter the trap when exiting its den.

Set as Single Or Double Door - Traps with two trap doors are more versatile because they can be set with only the front door as a baited trap or set both trap doors to use as a bait-less runway trap.

Traps with Two Trap Doors Featuring One Flush Mount Door

Model	Suggested Target Animal Size	L - W - H	Construction	Wt	Price	6+
102.5SS	Squirrel, Chipmunks, Rats	24 x 5 x 5	1/2 x 1 - 14 gauge	4 lbs	\$52.45	\$47.21
104SS	Squirrel, Rats	26 x 6 x 6	1/2 x 1 - 14 gauge	5lbs	\$58.85	\$52.97
105.5SS	Skunk, Prairie Dog	30 x 7 x 7	1/2 x 1 - 14 gauge	8 lbs	\$69.45	\$62.51
107SS	Raccoon, Groundhogs, Feral Cats	32 x 9 x 9	1/2 x 1 - 14 gauge	9 lbs	\$90.65	\$81.59
107.5SS	Raccoon, Groundhogs, Feral Cats	42 x 10 x 10	1/2 x 1 - 14 gauge	15 lbs	\$105.50	\$94.95
108.6SS	Large Raccoon, Groundhogs	42 x 10 x 12	1/2 x 1 - 14 gauge	18 lbs	\$126.70	\$114.03

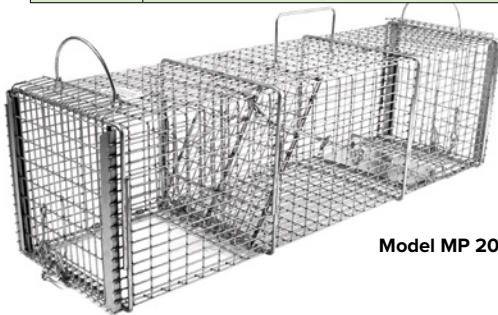

Model MP 200

Positive Set - Features a unique bottom opening which allows positive setting over dens/burrows.

Versatile - Can be used as a flush mount trap against walls, positive set over burrows or baited and set as a standard trap.

Easy Release Door - Rear door for easy baiting and removal of animals.

Flush Mount - Front panel can be removed to use as a flush mount, positive set trap against entry points on structures.

Multi-Purpose Trap With Built On Nose Cone

Model	Suggested Target Animal Size	L - W - H	Construction	Wt	Price	6+
MP100	Skunks, Prairie Dogs	30 x 8 x 8	1/2 x 1 - 14 gauge	9 lbs	\$94.85	\$85.37
MP200	Raccoon, Groundhogs	36 x 10 x 12	1/2 x 1 - 14 gauge	14 lbs	\$116.05	\$104.45
MP300	Large Raccoon, Groundhogs and Badger	42 x 12 x 12	1/2 x 1 - 14 gauge	19 lbs	\$137.25	\$123.53



Model 6010N

Mounting Loops - Features four quick mount loops for easy attachment to rooftops..

Litter Tray - Removable litter tray sits under the trap floor to catch waste from trapped animals to minimize damage.

Bait Cover - Sheet metal cover over bait area to prevent bait loss from weather and also provides shelter and hides trapped animals.

Flush Door - Positive sets against den and structure entry/exit points.

NWCOA Specialty Trap Featuring Mounting Loops, Removable Litter Catching Tray, Bait Cover and Flush Door

Model	Description	L - W - H	Construction	Wt	Price	6+
1010N	Roof/Attic Trap with Bait Cover, Mounting Loops and Litter Tray	32 x 10 x 11	1/2 x 1 - 14 gauge	17 lbs	\$129.50	\$116.55
6010N	Roof/Attic Trap with Bait Cover, Mounting Loops, Litter Tray and Rear Door	32 x 10 x 11	1/2 x 1 - 14 gauge	17 lbs	\$139.50	\$125.55



Tomahawk Live Trap
90 Years of Excellence
and Growing for the Future



"I look forward to coming to work every day and being a part of the team that makes the best animal control products in the world."

Chris Powers
Operations Coordinator

Comstock Series Traps

Comstock Series Traps are the strongest professional series traps available. These traps can be used in any position making them the best choice for positive sets.

They feature a wire trigger mechanism rather than a trip pan. This allows them to be set at any angle including vertical.

Tight mesh pattern throughout the trap to prevent animals from reaching in from the outside to steal bait and also from doing property damage after being trapped.

Strongest door springs of any cage trap available. The powered doors shut instantly allowing no chance of escape.

Heavy duty $\frac{1}{4}$ " steel frame wrapped with galvanized $\frac{1}{2}$ x 1 wire mesh and powder coated black.

PRODUCT HIGHLIGHTS

- **Powerful Trap Door Springs** - Comstock Series Traps feature our most powerful trap doors and instantly snap into place when the trap is triggered.
- **Set in Any Position** - After the trap is set it can be placed in any position including vertical making it a great trap for chimney sets and awkward positions.
- **No Trip Pan** - Comstock Series Traps are triggered by a swinging wire trigger mechanism or swinging panel which allows you to capture trap wise animals that are likely to avoid a standard trip pan trap.
- **Powder Coated**. All Comstock Series Traps come with a powder coated finish. (Excluding swing panel traps.)
- **Made in the USA**. Manufactured by Tomahawk Live Trap at our facility in Hazelhurst, Wisconsin.
- **Quality Assured**. Each trap is quality inspected and tested before it is shipped to you, our valued customer.



Model C911TD-36

Super strong coil springs - Powerful trap doors instantly snap into place when the trap is triggered. This prevents animals from backing out when the trap fires.

Locking trap doors - Locking doors prevent animals from escaping, even if the trap is flipped upside down.

WIRE TRIGGER - Comstock traps are triggered by a swinging push bar with wire triggers which allows you to capture the most trap shy animals that avoid a standard trip pan.

Function in any position - Can be set standard, upside down, sideways, or vertically.

COMSTOCK TRAPS COME POWDER COATED (except swing panel traps)

Comstock 9 x 11 Single Door

Model	L - W - H	Description	Wt	Construction	Price
C911SD-18	18 x 9 x 11	18" Single Door with Wire Trigger	11 lbs	1/2 x 1 - 14 gauge	\$84.25
C911SD-24	24 x 9 x 11	24" Single Door with Wire Trigger	12 lbs	1/2 x 1 - 14 gauge	\$87.45
C911SD-30	30 x 9 x 11	30" Single Door with Wire Trigger	13 lbs	1/2 x 1 - 14 gauge	\$90.65
C911SD-36	36 x 9 x 11	36" Single Door with Wire Trigger	14 lbs	1/2 x 1 - 14 gauge	\$93.80

Comstock 9 x 11 Single Door with Rear Bait Door

Model	L - W - H	Description	Wt	Construction	Price
C911BD-18	18 x 9 x 11	18" Single Door with Bait Door and Wire Trigger	11 lbs	1/2 x 1 - 14 gauge	\$94.85
C911BD-24	24 x 9 x 11	24" Single Door with Bait Door and Wire Trigger	12 lbs	1/2 x 1 - 14 gauge	\$98.05
C911BD-30	30 x 9 x 11	30" Single Door with Bait Door and Wire Trigger	13 lbs	1/2 x 1 - 14 gauge	\$101.25
C911BD-36	36 x 9 x 11	36" Single Door with Bait Door and Wire Trigger	14 lbs	1/2 x 1 - 14 gauge	\$104.40

Comstock 9 x 11 Single Door with Rear Release Sliding Door

Model	L - W - H	Description	Wt	Construction	Price
C911TD-18	18 x 9 x 11	18" Single Door with Release Door and Wire Trigger	11 lbs	1/2 x 1 - 14 gauge	\$101.25
C911TD-24	24 x 9 x 11	24" Single Door with Release Door and Wire Trigger	12 lbs	1/2 x 1 - 14 gauge	\$104.40
C911TD-30	30 x 9 x 11	30" Single Door with Release Door and Wire Trigger	13 lbs	1/2 x 1 - 14 gauge	\$107.60
C911TD-36	36 x 9 x 11	36" Single Door with Release Door and Wire Trigger	14 lbs	1/2 x 1 - 14 gauge	\$110.75

Two trap doors - Comstock double door traps feature two very powerful locking trap doors.

Versatile - Double door traps can be set as a single door trap with bait or set both trap doors to use as a bait-less runway trap. Traps featuring flush mount doors can also be placed as a positive set against entry points on structures or den openings.

Set in any position - Comstock traps can be set in any position making them an excellent choice for chimney and roof mounts.

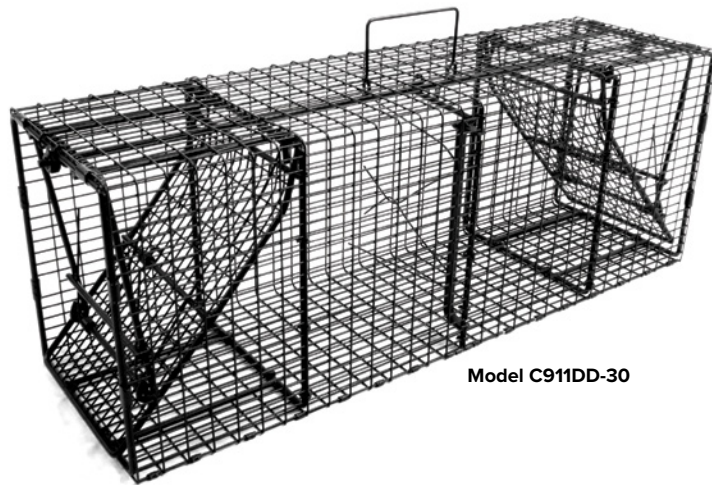

Model C911DD-30

Comstock 9 x 11 Double Door

Model	L - W - H	Description	Wt	Construction	Price
C911DD-18	18 x 9 x 11	18" Double Door with Wire Trigger	11 lbs	1/2 x 1 - 14 gauge	\$105.45
C911DD-24	24 x 9 x 11	24" Double Door with Wire Trigger	12 lbs	1/2 x 1 - 14 gauge	\$108.65
C911DD-30	30 x 9 x 11	30" Double Door with Wire Trigger	13 lbs	1/2 x 1 - 14 gauge	\$111.85
C911DD-36	36 x 9 x 11	36" Double Door with Wire Trigger	14 lbs	1/2 x 1 - 14 gauge	\$115.00

Comstock 9 x 11 Double Door with One Flush Mount Door

Model	L - W - H	Description	Wt	Construction	Price
C911FD-24	24 x 9 x 11	24" Double Door with One Flush Door and Wire Trigger	12 lbs	1/2 x 1 - 14 gauge	\$116.05
C911FD-30	30 x 9 x 11	30" Double Door with One Flush Door and Wire Trigger	13 lbs	1/2 x 1 - 14 gauge	\$119.25
C911FD-36	36 x 9 x 11	36" Double Door with One Flush Door and Wire Trigger	14 lbs	1/2 x 1 - 14 gauge	\$122.45

Comstock 9 x 11 Multi-Purpose Trap with Two Trap Doors

The Multi-Purpose trap is the most versatile Comstock Series Trap available. It features a built on nose cone with three panels for flush mounting in any direction or over den openings. It also features double trap doors to catch animals coming or going in and out of dens. The unique nose cone also allows for attaching multiple traps over a single den opening.

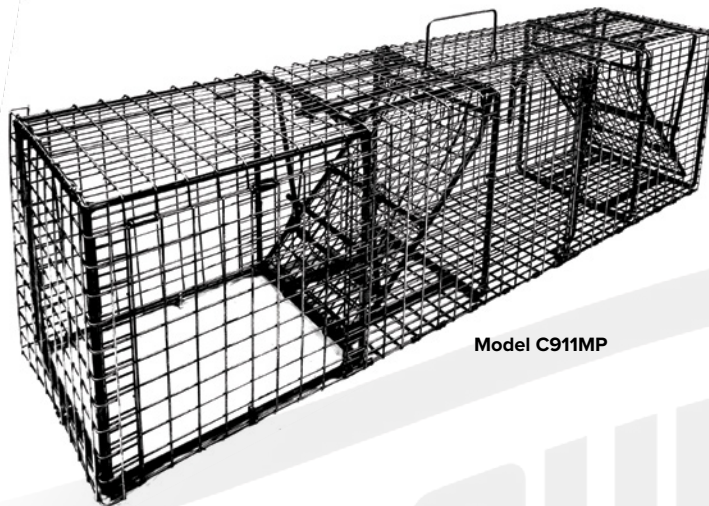

Model C911MP

Model	L - W - H	Description	Wt	Construction	Price
C911MP	36 x 9 x 11	36" Double Door, Multi-Purpose Trap with Attached Nose Cone and Wire Trigger	19 lbs	1/2 x 1 - 14 gauge	\$147.85

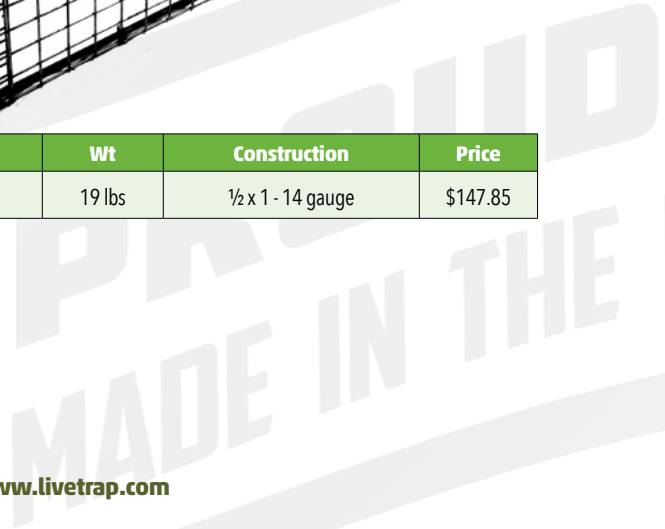

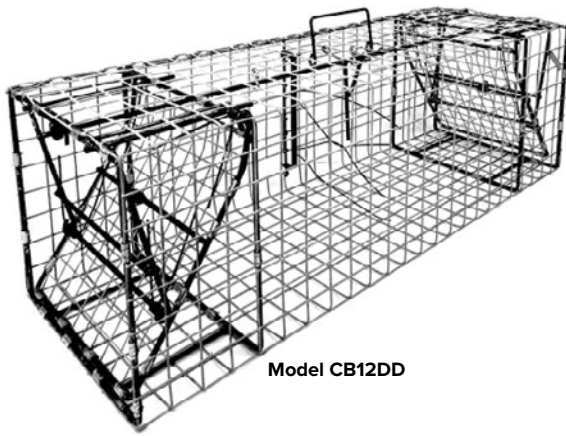

Model CB12DD

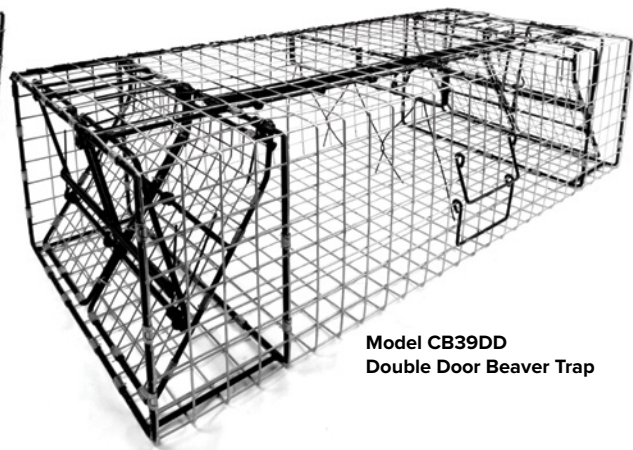

Model CB39DD
Double Door Beaver Trap

Comstock Beaver Trap

Model CB39DD is a unique beaver trap. It is designed for beavers and otters as a swim through trap to be used in water but can also be used on land. This heavy duty professional beaver trap is triggered by a swing bar wire trigger mechanism which allows you to capture the most trap shy animals and does not have a trip pan for animals to avoid. It is especially effective for using in a beaver dam set by punching a hole into the dam and placing the trap upstream just before the hole. When a beaver hears the trickle of the water it will come to plug the dam and pass through the trap setting it off and capturing it inside.

Model	Description	L - W - H	Construction	Wt	Price
CB39DD	Double Door Beaver Trap with Wire Trigger	39 x 18 x 12	1½ x 1½ - 12 gauge	23 lbs	\$264.45
CB39DDED	Double Door Beaver Trap with Wire Trigger and Otter Escape Door	39 x 18 x 12	1½ x 1½ - 12 gauge	23 lb	\$280.35

Comstock 12x12 Trap

Comstock 12" x 12" traps are made for otter, beaver, large raccoon and similar size animals. Like the larger swim through Comstock Beaver Cage Trap, the 12x12 double door model can be used for beaver in a dam setting by punching a hole in the dam and placing the trap in front of the hole to capture a beaver that is coming to repair the dam. It can also be used in tighter runs or on land. This trap also uses a swing bar wire trigger mechanism. 12 x 12 traps are also available with a tighter ½" x 1" wire mesh in a double door, single door, single door with bait door and single door with release door style.

Model	Description	L - W - H	Construction	Wt	Price
CB12DD-36	36" Double Door with Wire Trigger	36 x 12 x 12	1½ x 1½ - 12 gauge	16 lbs	\$158.45
C12DD-36	36" Double Door with Wire Trigger	36 x 12 x 12	½ x 1 - 14 gauge	16 lbs	\$158.45
C12BD-36	36" Single Door with Rear Bait Door and Wire Trigger	36 x 12 x 12	½ x 1 - 14 gauge	16 lbs	\$147.85
C12TD-36	36" Single Door with Release Door and Wire Trigger	36 x 12 x 12	½ x 1 - 14 gauge	16 lbs	\$154.25
C12SD-36	36" Single Door with Wire Trigger	36 x 12 x 12	½ x 1 - 14 gauge	16 lbs	\$137.25

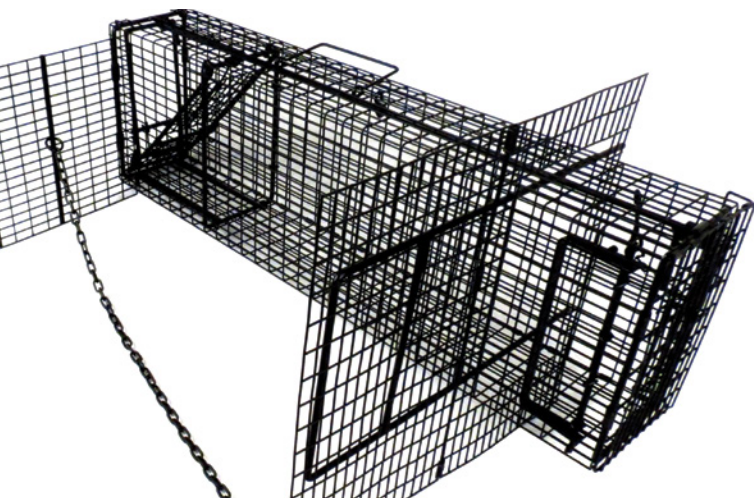

Model C59CHIM is a trap designed to capture raccoons living in chimneys. It is designed to be dropped into a chimney from the top, and can be completely hidden from sight. It consists of the trap, trap flap, trap flap chain, trap stop, and chimney top mesh screen. The trap stop allows you to drop the trap into the chimney at any depth you prefer, the chimney top mesh screen will rest under the trap stop to prevent raccoons from entering the chimney from the outside. The trap flap will prevent raccoons from exiting the chimney and avoiding the trap. After the trigger mechanism is set with the trap stop in place, the trap can be lowered into the chimney.

Comstock Chimney Trap

Model	Description	L - W - H	Construction	Wt	Price
C59CHIM	30" Chimney Trap	30 x 5 x 8	1/2 x 1 - 14 gauge	9 lbs	\$153.70

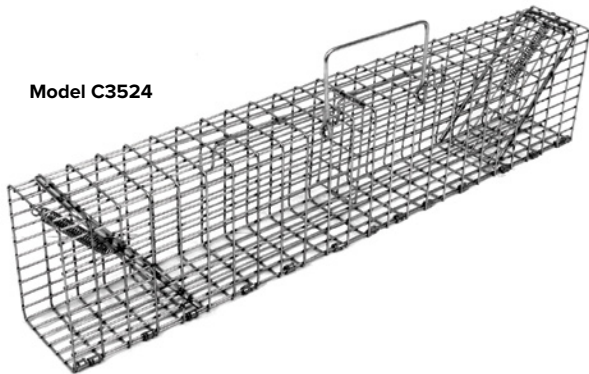

Model C3524

Comstock Series Swing Panel Traps

- No Trip Pan- Comstock Series Swing Panel Traps are triggered by a swinging panel mechanism set off when an animal bumps into it while trying to get through the trap.
- Two Trap Doors - These swing panel traps feature two trap doors allowing for bait-less runway setting. The 3x5" trap is especially great for setting in gutters to catch squirrels using them as pathways.
- Flush Doors - Both trap doors are flush mount doors so the trap can be placed directly over entry/exit points.
- Versatile - Can also be set as a single door trap with bait by simply placing bait beyond the trigger panel and only setting one trap door. These traps can also be converted to multiple catch colony traps by simply removing the door spring.

Comstock Swing Panel Traps

Model	Description	L - W - H	Construction	Wt	Price
C3524	Double Doors Fits Gutters for Squirrels, Chipmunks	24 x 3 x 5	½ x 1 - 14 gauge	2 lbs	\$32.60
C5524	Double Door for Squirrels, Chipmunks, Gophers	24 x 5 x 5	½ x 1 - 14 gauge	3 lbs	\$34.70
C6626	Double Door for Squirrels, Chipmunks, Gophers	26 x 6 x 6	½ x 1 - 14 gauge	4 lbs	\$37.90
C6830	Double Door for Squirrels, Skunks, Rabbits, Cats	30 x 8 x 6	½ x 1 - 14 gauge	5 lbs	\$42.15
C7732	Double Door for Squirrels, Skunks, Rabbits, Cats	32 x 7 x 7	½ x 1 - 14 gauge	6 lbs	\$42.15
C7736	Double Door for Squirrels, Skunks, Rabbits, Cats	36 x 7 x 7	½ x 1 - 14 gauge	7 lbs	\$42.15
C81036	Double Door for Rabbits, Skunks, Cats, Opossum	36 x 10 x 8	1 x 1 - 14 gauge	7 lbs	\$47.45



Nose Cone for 9x11 Traps



Door Setter

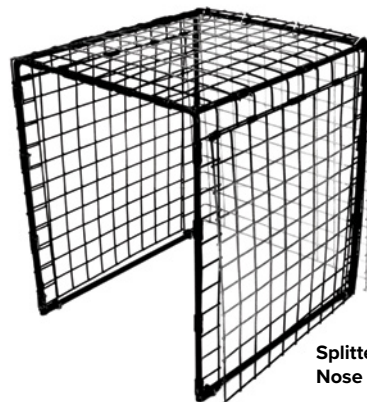

Splitter / 3-Way Nose Cone

Comstock Accessories

Model	Description	L - W - H	Construction	Wt	Price
C911CA	Chimney Adapter	24 x 9 x 11	½ x 1 - 14 gauge	6 lbs	\$62.55
C911FMA	Flush Mount for 9 x 11 Comstock Traps	6 x 9 x 11	1 x 1 - 14 gauge	2.5 lbs	\$28.15
C1212FMA	Flush Mount for 12 x 12 Comstock Traps	7 x 12 x 12	1 x 1 - 14 gauge	3.5 lbs	\$31.75
C911NC-18	Nose Cone for 18" Comstock 9x11 Traps	18 x 9½ x 11	Sheet Metal with 1 x 1 - 14g flap	4 lbs	\$34.45
C911NC-24	Nose Cone for 24" Comstock 9 x 11 Traps	24 x 9½ x 11	Sheet Metal with 1 x 1 - 14g flap	5 lbs	\$36.57
C911NC-30	Nose Cone for 30" Comstock 9 x 11 Traps	30 x 9½ x 11	Sheet Metal with 1 x 1 - 14g flap	5 lbs	\$38.69
C911NC-36	Nose Cone for 36" Comstock 9 x 11 Traps	36 x 9½ x 11	Sheet Metal with 1 x 1 - 14g flap	5 lbs	\$40.81
C911SP	3 way nose cone / splitter for 9x11 Comstock Traps	12 x 11 x 11	1 x 1 - 14 gauge	4 lbs	\$41.34
C1212SP	3 way nose cone / splitter for 12x12 Comstock Traps	13 x 13 x 13	1 x 1 - 14 gauge	5 lbs	\$46.64
CN357	Nose Cone for C3524 Comstock Trap	7 x 3 ½ x 3 ½	½ x 1 - 14 gauge	1 lb	\$16.70
CN557	Nose Cone for C5524 Comstock Trap	7 x 5 ½ x 5 ½	½ x 1 - 14 gauge	1 lb	\$16.70
CN668	Nose Cone for C6624 Comstock Trap	8 x 6 x 6	½ x 1 - 14 gauge	1.5 lbs	\$19.88
CDS	Comstock Door Setter		1/4" Rod	.5 lb	\$21.15
CED	Escape Door Kit for Beaver Trap		1 ½ x 1 ½ - 12 gauge	.5 lb	\$15.85



"I enjoy working for a family owned business because they treat you like a person and listen to your ideas. I'm not just a number here. I'm part of a team."

Tracy
Repeating Trap &
Excluder Specialist

The Tomahawk Feral Cat Traps

We worked closely with the Neighborhood Cats, Fix Nation and other rescue organizations around the country to design a series of traps and handling equipment made specifically for feral cats.

Feral Cat Series Traps include extra features for the safe capture and handling of feral cats. An extra large hand protector on the top of the trap prevents the handler from being scratched or bitten when transporting a trapped animal. An extra large trip plate in the trap prevents cats from stepping over the trip plate to avoid capture. A rear sliding access door with a lock on top of the trap makes transfer of cats, baiting and releasing almost too easy. A strategically placed tight mesh pattern at the rear of the trap prevents cats from reaching in and stealing the bait from the outside.

The Neighborhood Cats Drop Trap also offers a unique method for catching trap shy cats or a group of cats at one time.

Tomahawk Feral Cat Series Traps are simply the most effective feral cat traps available and offer a safe and reliable way to help reduce feral cat populations around the world.

PRODUCT HIGHLIGHTS

- XL Trip pan prevents cats from stepping over and stealing bait without being captured
- Easy release door provides the safest and easiest way to bait, transfer, and release trapped cats.
- XL Hand guard for added protection from scratches and bites
- XL double handles for lifting and transporting
- Strategic mesh pattern to prevent cats from reaching in and stealing bait

MADE IN THE USA

Model 608NC



Feral Cat Series Traps Feature:

- Extra large trip pan to prevent cats from stepping over it to steal the bait and not get caught.
- Extra large hand guard for added protection from scratches, also convenient for labels.
- Easy release door provides the safest and easiest way to release trapped animals.
- Extra large, double trap handles makes lifting a breeze, as two hands can be used to lift and stabilize the trap.

Feral Cat Series Traps

Model	Description	L - W - H	Construction	Wt	Price	6+
605NC	Neighborhood Cats Trap 30"	30 x 10 x 10	1 x 1 - 14 gauge	8.5 lbs	\$66.80	\$60.12
606NC	Neighborhood Cats Trap 30"	30 x 10 x 12	1 x 1 - 14 gauge	10 lbs	\$68.90	\$62.01
608NC	Neighborhood Cats Trap 36"	36 x 10 x 12	1 x 1 - 14 gauge	11 lbs	\$71.00	\$63.90
608FN	FixNation Cat Trap 32"	32 x 10 x 12	1 x 2 - 12 gauge	11 lbs	\$71.00	\$63.90
206NC	Collapsible Neighborhood Cat Trap 30"	30 x 10 x 12	1 x 1 - 14 gauge	10 lbs	\$79.50	\$71.55

Original Series Cat Traps

Model	Description	L - W - H	Construction	Wt	Price	6+
606	Cats, Rabbits, and Similar Sizes	26 x 9 x 9	1 x 1 - 14 gauge	7 lbs	\$63.35	\$57.02
606.3	Cats, Rabbits, and Similar Sizes	30 x 9 x 9	1 x 1 - 14 gauge	7 lbs	\$65.70	\$59.13
609	XL Cat Trap	36 x 12 x 14	1 x 1 - 14 gauge	14 lbs	\$105.75	\$95.18

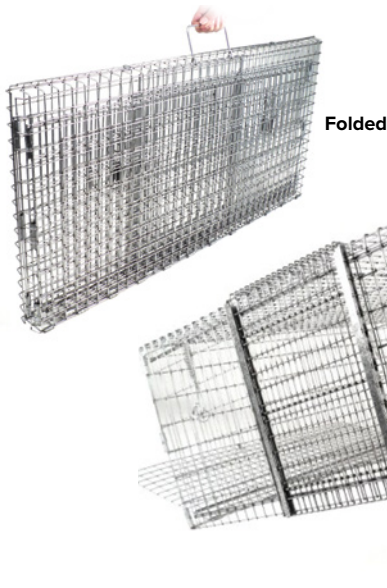

Our Collapsible Neighborhood Cats Drop Trap is sturdy, yet light weight at just 18 lbs. It sets up easily in seconds with no tools required and measures 36" x 36" x 14" when deployed. It collapses just as easily and measures 36" x 18" x 4" for easy transport or storage. This convenient trap allows you to catch those wary, trap shy cats that won't enter traditional traps. It comes with an attached prop, easy release door, attached weight flap, and transfer cage spring clips. The easy release door is sized to match perfectly with our model 306NC transfer cage. The spring clips allow you to securely attach the transfer cage to the drop trap eliminating the need for cumbersome and less effective bungee cords. And the weight flap allows you to secure the trap to prevent trapped cats from sliding the trap around.

- Drop traps can be purchased separately or with an included transfer cage as a KIT for greater savings.
- A remote control trigger is also available for model DT1. It can be purchased separately or in a KIT for greater savings.

Neighborhood Cats Collapsible Drop Trap

Model	Description	L - W - H	Construction	Wt	Price	6+
DT1	Neighborhood Cats Drop Trap - Collapsible	36 x 36 x 14	1 x 2 - 12 gauge	18 lbs	\$105.45	\$94.91
DT2	XL Drop Trap - Collapsible	48 x 48 x 14	1 x 2 - 12 gauge	26 lbs	\$158.45	\$142.61

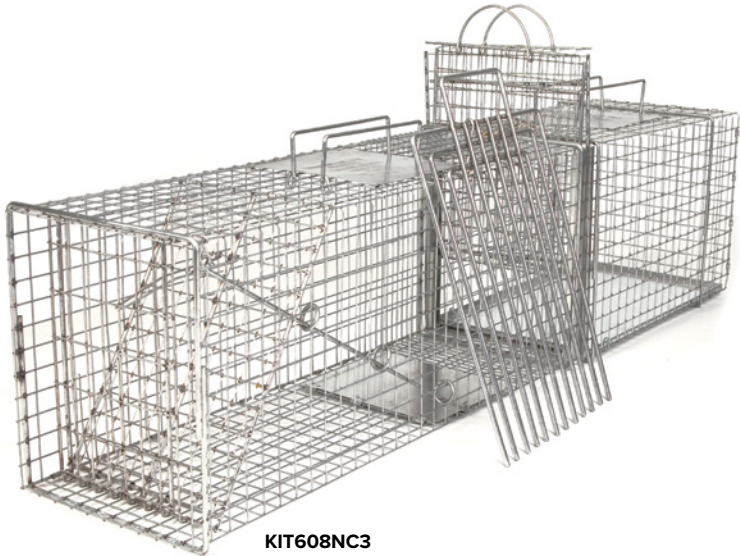

KIT608NC3



KIT608NC1

Kits allow you to bundle traps, dividers, and cages in a variety of ways and provide you with greater savings.

Feral Cat Trap Kits

Model	Description	Price
KIT605NC1	605NC - 30 x 10 x 10 Cat Trap, TD12NC Trap Divider	\$100.70
KIT605NC2	605NC - 30 x 10 x 10 Cat Trap, (2) TD12NC Trap Dividers	\$127.20
KIT605NC3	605NC - 30 x 10 x 10 Cat Trap, 306NC Transfer Cage, TD12NC Trap Divider	\$166.40
KIT606NC1	606NC - 30 x 10 x 12 Cat Trap, TD12NC Trap Divider	\$102.80
KIT606NC2	606NC - 30 x 10 x 12 Cat Trap, (2) TD12NC Trap Dividers	\$129.30
KIT606NC3	606NC - 30 x 10 x 12 Cat Trap, 306NC Transfer Cage, TD12NC Trap Divider	\$168.55
KIT606NC4	606NC - 30 x 10 x 12 Cat Trap, 306NC Transfer Cage, C306 Connection Piece, TD12NC Trap Divider	\$190.80
KIT608NC1	608NC - 36 x 10 x 12 Cat Trap, TD12NC Trap Divider	\$113.40
KIT608NC2	608NC - 36 x 10 x 12 Cat Trap, (2) TD12NC Trap Dividers	\$139.90
KIT608NC3	608NC - 36 x 10 x 12 Cat Trap, 306NC Transfer Cage, TD12NC Trap Divider	\$179.15
KIT608NC4	608NC - 36 x 10 x 12 Cat Trap, 306NC Transfer Cage, C306 Connection Piece, TD12NC Trap Divider	\$200.35
KIT608FN1	608FN - 32 x 10 x 12 Cat Trap, TD12NC Trap Divider	\$113.40
KIT608FN2	608FN - 32 x 10 x 12 Cat Trap, (2) TD12NC Trap Dividers	\$139.90
KIT608FN3	608FN - 32 x 10 x 12 Cat Trap, 306NC Transfer Cage, TD12NC Trap Divider	\$179.15
KIT608FN4	608FN - 32 x 10 x 12 Cat Trap, 306NC Transfer Cage, C306 Connection Piece, TD12NC Trap Divider	\$200.35
KIT206NC1	206NC - 30 x 10 x 12 Collapsible Cat Trap, TD12NC Trap Divider	\$121.90
KIT206NC2	206NC - 30 x 10 x 12 Collapsible Cat Trap, (2) TD12NC Trap Dividers	\$148.40
KIT206NC3	206NC - 30 x 10 x 12 Collapsible Cat Trap, 306NC Transfer Cage, TD12NC Trap Divider	\$187.60
KITDT1	DT1 - Drop Trap, 306NC Transfer Cage	\$187.60
KITDT2	DT1 - Drop Trap, RC100 Remote Trigger, DTRA Remote Drop Trap Attachment	\$275.60
KITDT3	DT1 - Drop Trap, 306NC Transfer Cage, RC100 Remote Trigger, DTRA Remote Drop Trap Attachment	\$328.60
KITDT1XL	DT2 - XL Drop Trap, 306NC Transfer Cage	\$240.60

All Kit prices include shipping to anywhere in the contiguous USA

Model 306TX



Model 306NC2



Model 30622

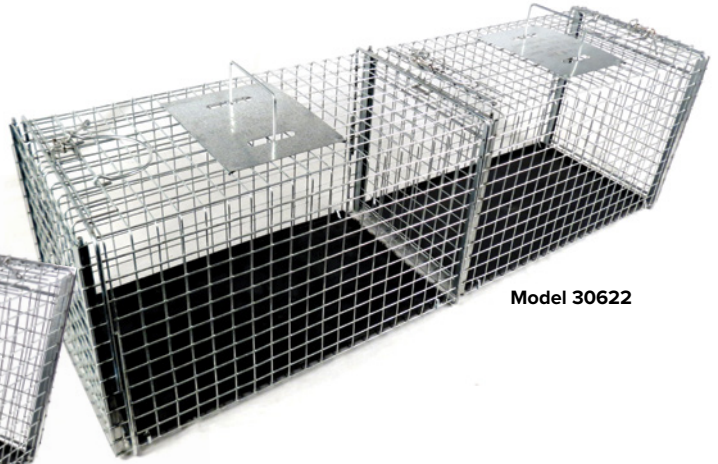

Transfer Cage

Model	Description	L - W - H	Construction	Wt	Price	6+
306NC	Transfer Cage for Cat Traps - 206NC, 606NC, 608NC, 608FN, DT1	20 x 11 x 12	1 x 1 - 14 gauge	8 lbs	\$62.55	\$56.30
306NC2	Two Door Transfer Cage for 206NC, 606NC, 608NC, 608FN, DT1, DT2	21 x 11 x 12	1 x 1 - 14 gauge	9 lbs	\$73.65	\$66.29
306TX	Set Over Capture Cage	21x11x12	1 x 1 - 14 gauge	10 lbs	\$83.75	\$75.38
30622	Two Chamber Feral Cat Cage	42 x 11 x 12	1 x 1 - 14 gauge	12 lbs	\$105.45	\$94.94

C306

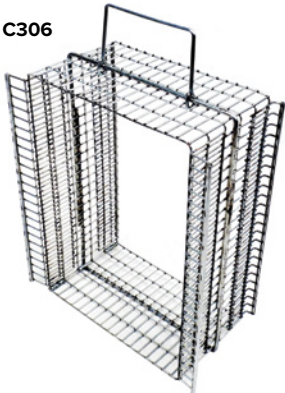

C306 Connection piece in use.



C306 - Connection Piece

Connection piece for 10 x 12 Feral Cat Traps and Model 306NC Transfer Cage. This simple accessory is a life changer for recovering cats. Simply slide the connection piece into the door slides of the trap and transfer cage to instantly gain additional recovery space or a connected litter cage.



DLT Disposable Litter Tray inside Model 306NC Transfer Cage

DLT- Disposable litter tray

Disposable litter trays are cardboard litter pans with water resistant coating designed to fit perfectly into our model 306NC and 306 transfer cages. Sold individually or in packs of 50.

Model	Description	Traps & Cages To Use With	Construction	Price	6+
C306	Cage to Trap Connector	Traps: 606NC, 608NC, 608FN Transfer Cages: 306NC, 306NC2, 306, 306DD, 30622	½ x 1 - 14 gauge	\$31.25	\$28.13
C307	Cage to Cage Connector	Transfer Cages: 306NC, 306NC2, 30622	½ X 1 - 14 gauge	\$31.25	\$28.13
DLT	Disposable Litter Tray for 306NC Cages	Transfer Cages: 306NC, 306NC2, 30622	Water Resistant Cardboard	\$2.15	\$1.94
DLT50	Disposable Litter Tray for 306NC Cages / 50 Pack	Transfer Cages 306NC, 306NC2, 306, 306DD, 30622	Water Resistant Cardboard	\$79.50	\$71.55

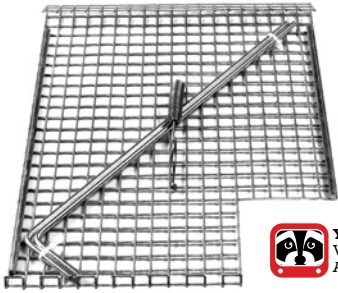

Neighborhood Cats Kitten Screen



The Neighborhood Cats Kitten Screen allows you to catch kittens only. It is designed with a unique 3"x 3" opening that blocks mature cats and allows kittens only to enter the trap. It installs easily in seconds with no tools required. Fits trap models 206NC, 606NC, 608NC, 608FN, 108, and 608.



Trap Caddie



NC1012 - clear sliding rear door

"See Through" Clear Rear Sliding Door for 10 x 12 Feral Cat Traps. The Neighborhood Cats "See Through" Rear Release Door is designed to fool the smartest and most trap shy cats. The clear acrylic rear release door allows cats to see completely through the trap and fools them into believing they can walk through. NC1012 is designed to fit trap models 606NC, 608NC, and 608FN.

Miscellaneous Accessories

Model	Description	Traps To Use With Accessory	Construction	Price	6+
KS100	Neighborhood Cats Kitten Screen	206NC, 606NC, 608NC, 608FN, 608, 108 & All Other 10x12 Traps	1/2 x 1/2- 14 gauge	\$21.20	\$19.08
C1012	Trap Caddie	Works With All Cage Traps	Chain & PVC Pipe	\$21.20	\$19.08
NC1012	Clear Rear Door for 10" wide x 12" tall Traps	606NC, 608NC, 608FN, 608, 608SS, 608.2, 608.2SS	Acrylic	\$21.15	\$19.04
NC1010	Clear Rear Door for 10" wide x 10" tall Traps	605NC, 6010, 6010SS	Acrylic	\$21.15	\$19.04
NC0909	Clear Rear Door for 9" wide x 9" tall Traps	606, 606.3, 606SS	Acrylic	\$21.15	\$19.04



RC100 - Remote Control Trigger System



The Remote Control Trap Trigger - allows you to trigger your trap remotely with a radio controlled transmitter. This gives you the ability to target specific animals. It installs easily to all Tomahawk cat traps.

NEW Drop Trap Attachment - Now you can remotely trigger your Drop Trap from up to 200 feet away with the remote control Drop Trap attachment and prop. Simply pull the trigger on the remote control unit to drop the trap. Will NOT work with XL Drop Trap model DT2

Remote Control Trigger & Accessories

Model	Description	Price	6+
RC100	Remote Control Trigger System	\$148.35	\$133.52
DTRA	Drop Trap Mounting Bracket and Prop - for use with Remote Control Trigger System	\$21.15	\$19.04

Cat Den/
Animal
Carrier



These units provide animals a quiet place to hide within larger holding pens. They can also be used as transfer cages as they match up nicely to the easy release door of our cat traps and cages.

Our cat dens are easy to disinfect as there are no nuts or bolts protruding into the inside of the unit. They have an acrylic sliding door to allow handlers to check on animals without disturbing them. And they have a porthole door with flip down cover. Simply close the porthole door to secure the animal inside, then remove the unit from the cage for cleaning, treatment, or transport.

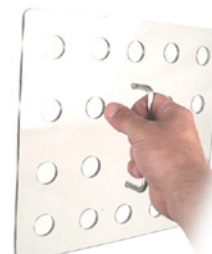

Animal Shield

This hand shield was designed to fit our plastic Cat Dens. It measures 9.5W x 10.5H. The hand shield provides protection from scratches and bites and gives the handler control of the animal for examinations or injections.

Cat Den/Animal Carrier

Model	Description	L - W - H	Construction	Wt	Price	6+
711S	White Feral Cat Den with Smoke Door	17 x 12 x 12	Polyethylene	7 lbs	\$79.95	\$71.96
711C	White Feral Cat Den with Clear Door	17 x 12 x 12	Polyethylene	7 lbs	\$79.95	\$71.96
721S	Grey Feral Cat Den with Smoke Door	17 x 12 x 12	Polyethylene	7 lbs	\$79.95	\$71.96
721C	Grey Feral Cat Den with Clear Door	17 x 12 x 12	Polyethylene	7 lbs	\$79.95	\$71.96
731S	Tan Feral Cat Den with Smoke Door	17 x 12 x 12	Polyethylene	7 lbs	\$79.95	\$71.96
731C	Tan Feral Cat Den with Clear Door	17 x 12 x 12	Polyethylene	7 lbs	\$79.95	\$71.96

Animal Shield for Cat Den

Model	Description	L - W - H	Construction	Wt	Price	6+
HS1	Clear Animal Shield for 711, 721 & 731 Cat Dens	10.5 x 9.5	Clear Acrylic	1 lb	\$25.00	\$22.50
HS2	Clear animal shield for shelter cages.	15 x 15	Clear Acrylic	2 lbs	\$30.00	\$27.00

We can custom make any size of animal shield, call us for a quote.

Pet carriers are shipped flat, but set up easily to 17 1/2" x 8 1/2" x 15". They are one piece cardboard construction with all joints glued for extra support. A special coating provides moisture resistance. Extra air holes provide excellent ventilation. The one piece carriers come with double locking side panels.



Disposable Pet Carriers

Model	Description	L - W - H	Construction	Wt	Price-Packs of 25
DPC1	25 Pack of Disposable Pet Carriers	17.5 x 8.5 x 15	Cardboard	25 lbs	\$75.00

Tomahawk cages are built from heavy duty galvanized wire mesh and reinforced steel frames. They feature handle protectors to prevent biting or scratching and removable floor pans for easy cleaning. We manufacture top opening, end opening, transfer and double door cages in a variety of sizes.

End Opening Cages

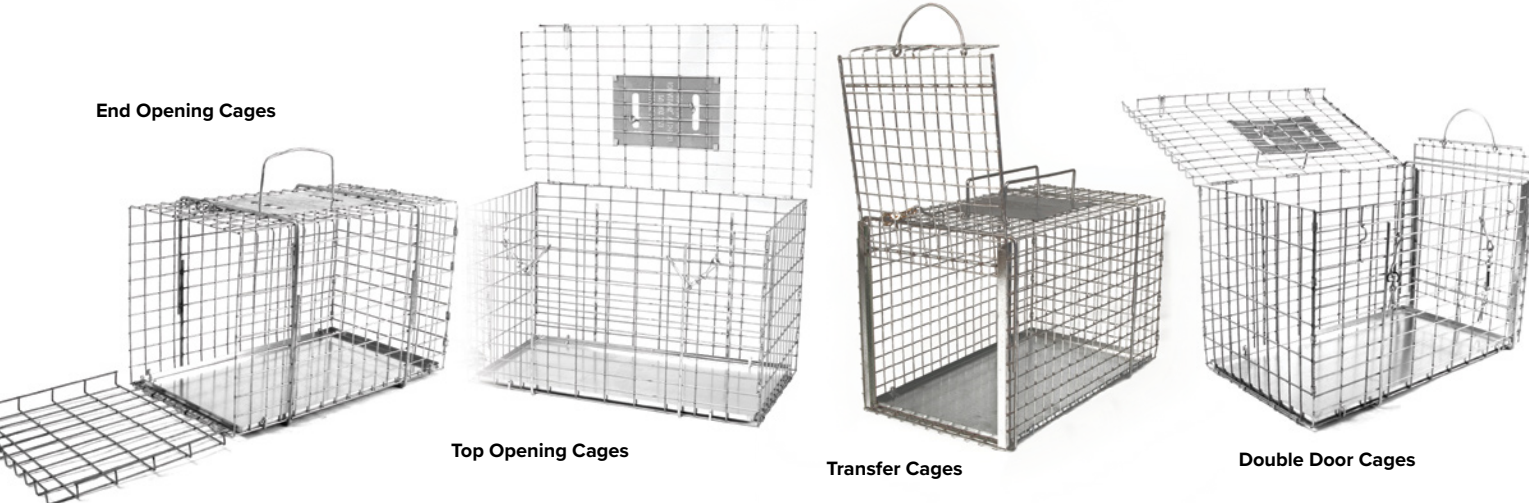

Top Opening Cages

Transfer Cages

Double Door Cages

Top Opening Cages The entire top of these cages is a swinging door for placing animals in and out of the cage

Model	Suggested Animal Sizes	L - W - H	Construction	Wt	Price	6+
301	Opossum, Rabbit, Skunk	16 x 9 x 10	1 x 1 - 14 gauge	4 lbs	\$46.75	\$42.08
303	Raccoon, Feral Cat	20 x 11 x 12	1 x 1 - 12 gauge	6 lbs	\$54.90	\$49.41

End Opening Cages One entire end of these cages is a swinging door for placing animals in and out of the cage.

Model	Suggested Animal Sizes	L - W - H	Construction	Wt	Price	6+
302	Opossum, Rabbit, Skunk	16 x 9 x 10	1 x 1 - 14 gauge	5 lbs	\$46.75	\$42.08
304	Raccoon, Feral Cat	20 x 11 x 12	1 x 1 - 12 gauge	7 lbs	\$54.90	\$49.41

Transfer Cages

One entire end of these cages is a sliding door designed especially for easy transfer of animals from a "Easy Release" trap. Our transfer cages are built to specific sizes that match traps with easy release doors. Simply line up the door end of the cage with the easy release door of your trap, and pull the release doors up and out of the way. After the animal is moved to the cage, replace the door and latch into place. Your trap can now be redeployed.

Model	Suggested Animal Sizes	L - W - H	Construction	Wt	Price	6+
305	Opossum, Rabbit, Skunk	16 x 9 x 10	1 x 1 - 14 gauge	5 lbs	\$52.05	\$46.85
306	Raccoon, Feral Cat	20 x 11 x 12	1 x 1 - 12 gauge	7 lbs	\$60.20	\$54.18
306NC	Feral Cat Series Transfer Cage	20 x 11 x 12	1 x 1 - 14 gauge	7 lbs	\$62.55	\$56.30
306NC2	Feral Cat Series Transfer Cage with Two Transfer Doors	21 x 11 x 12	1 x 1 - 14 gauge	8 lbs	\$73.65	\$66.29
30622	Feral Cat Series Two Chamber Transfer Cage	42 x 11 x 12	1 x 1 - 14 gauge	12 lbs	\$105.45	\$94.91
333	Professional Series Three Chamber Transfer Cage	36 x 10 x 12	½ x 1 - 14 gauge	13 lbs	\$105.45	\$94.91
307	Small Dog, Fox	26 x 12 x 16	1 x 2 - 12 gauge	11 lbs	\$77.30	\$69.57
308	Medium Dog	30 x 16 x 20	1 x 2 - 12 gauge	17 lbs	\$104.45	\$94.01
309	Large Dog, Coyote	36 x 20 x 26	1 x 2 - 12 gauge	24 lbs	\$149.75	\$134.78

Double Door Cages Double door cages have top opening and transfer style opening doors.

Model	Suggested Animal Sizes	L - W - H	Construction	Wt	Price	6+
305DD	Opossum, Rabbit, Skunk	16 x 9 x 10	1 x 1 - 14 gauge	5 lbs	\$62.65	\$56.39
306DD	Raccoon, Feral Cat	20 x 11 x 12	1 x 1 - 12 gauge	7 lbs	\$70.80	\$63.72
307DD	Small Dog, Fox	26 x 12 x 16	1 x 2 - 12 gauge	11 lbs	\$87.90	\$79.11

Restraint Modules

Restraint Modules are specifically designed for easy handling of animals during injections, examinations, or anytime absolute control of the animal is a must. The sliding panel locks into any position the handler desires, and will comfortably hold the animal. The restraint module can be operated with one hand and only requires one individual to operate. Heavy reinforcing rods are welded to the wire frame for extra support and easy release doors on both ends allows for easy transferring of animals. Our restraint modules match up nicely to our traps and cages with easy release doors.

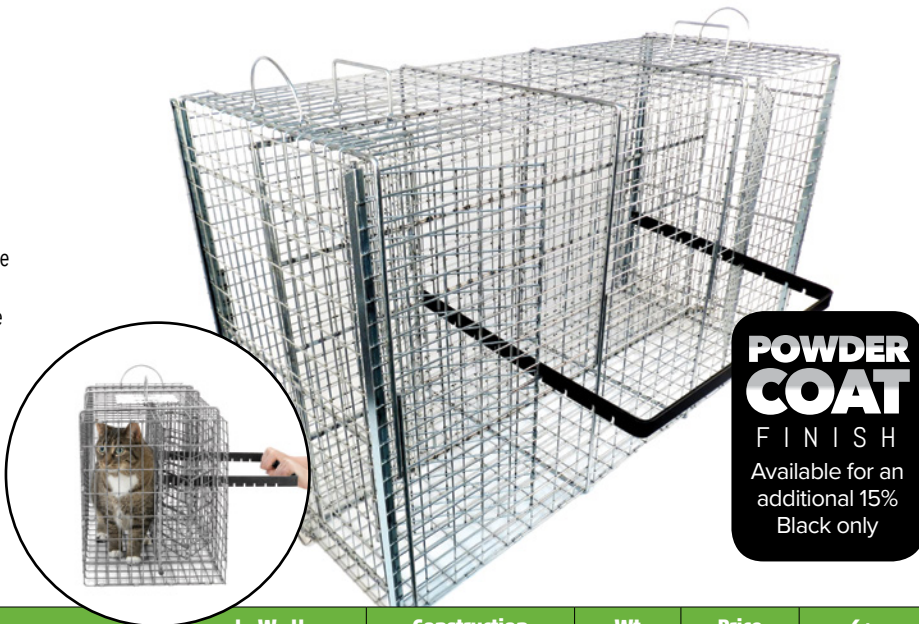

Model	Suggested Animal Sizes	L - W - H	Construction	Wt	Price	6+
RM306NC	Feral Cats	21 x 11 x 12	1 x 1 - 14 gauge	12 lbs	\$150.00	\$135.00
RM24	Rabbits, Cats, Opossum	24 x 9 x 11	1 x 1 - 14 gauge	11 lbs	\$170.00	\$153.00
RM30	Feral Cats, Raccoon	30 x 12 x 14	1 x 2 - 12 gauge	17 lbs	\$200.00	\$180.00
RM42	Small to Medium Size Dogs	42 x 17 x 24	1 x 2 - 12 gauge	41 lbs	\$280.00	\$252.00

Squeeze Cages

Squeeze Cages are perfect for vaccinating and examining animals. Simply slide the squeeze panel forward until the animal is firmly held between the panel and the side of the cage. The bottom tray can be removed for easy cleaning, the handles fold flat for easy storage, and an easy release door is provided for easy transfer of the animal.

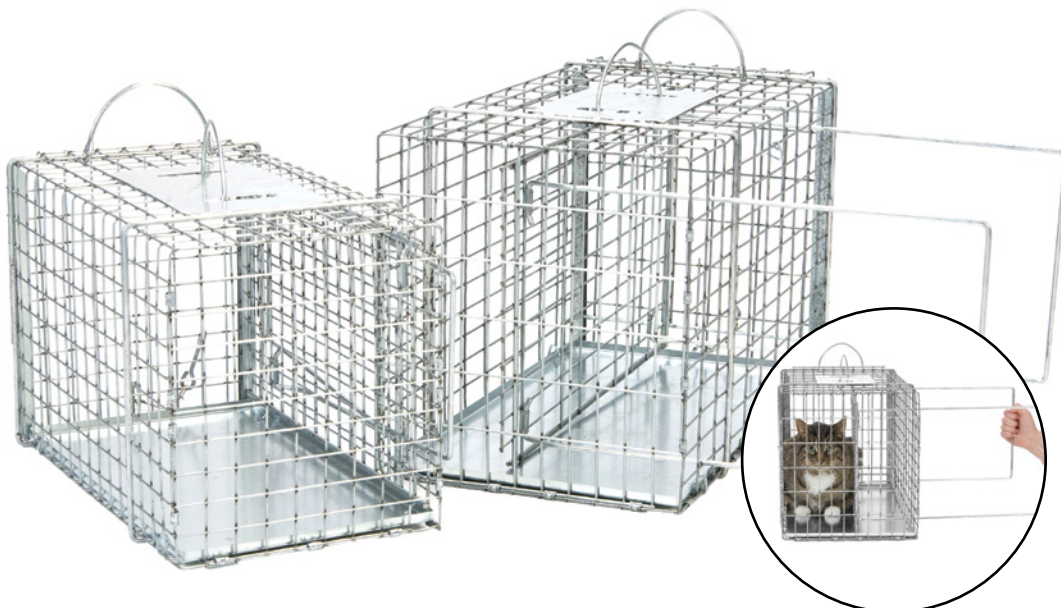

Model	Suggested Animal Sizes	L - W - H	Construction	Wt	Price	6+
305SQ	Rabbits, Cats, Opossum	16 x 9 x 10	1 x 1 - 14 gauge	6 lbs	\$80.50	\$72.45
306SQ	Feral Cats, Raccoon	20 x 11 x 12	1 x 1 - 12 gauge	10 lbs	\$93.40	\$84.06
306NCSQ	NC Squeeze Cage for Feral Cats	20 x 11 x 12	1 x 1 - 14 gauge	10 lbs	\$93.40	\$84.06
306NC2SQ	NC Two Transfer Door Squeeze Cage for Feral Cat	21 x 11 x 12	1 x 1 - 14 gauge	10 lbs	\$105.00	\$94.50
307SQ	Small Dogs, Fox	26 x 12 x 16	1 x 2 - 12 gauge	11 lbs	\$110.00	\$99.00
308SQ	Average Dog Size	30 x 16 x 20	1 x 2 - 12 gauge	20 lbs	\$140.00	\$126.00



 **NEW PRODUCT**

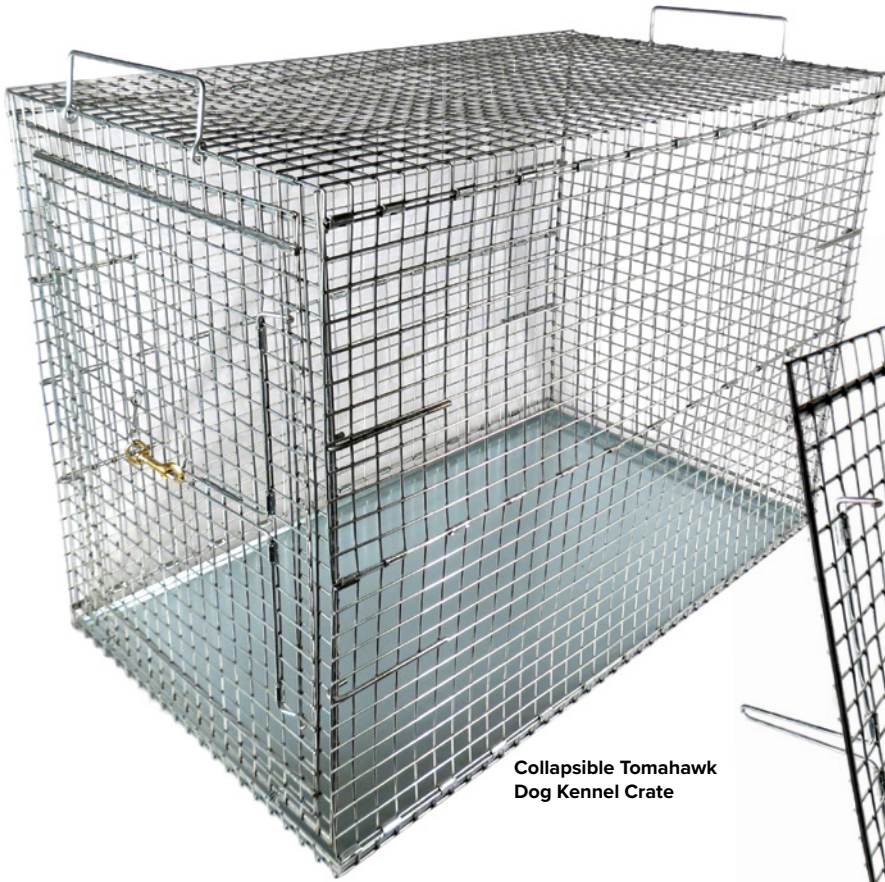

Collapsible Tomahawk Dog Kennel Crate

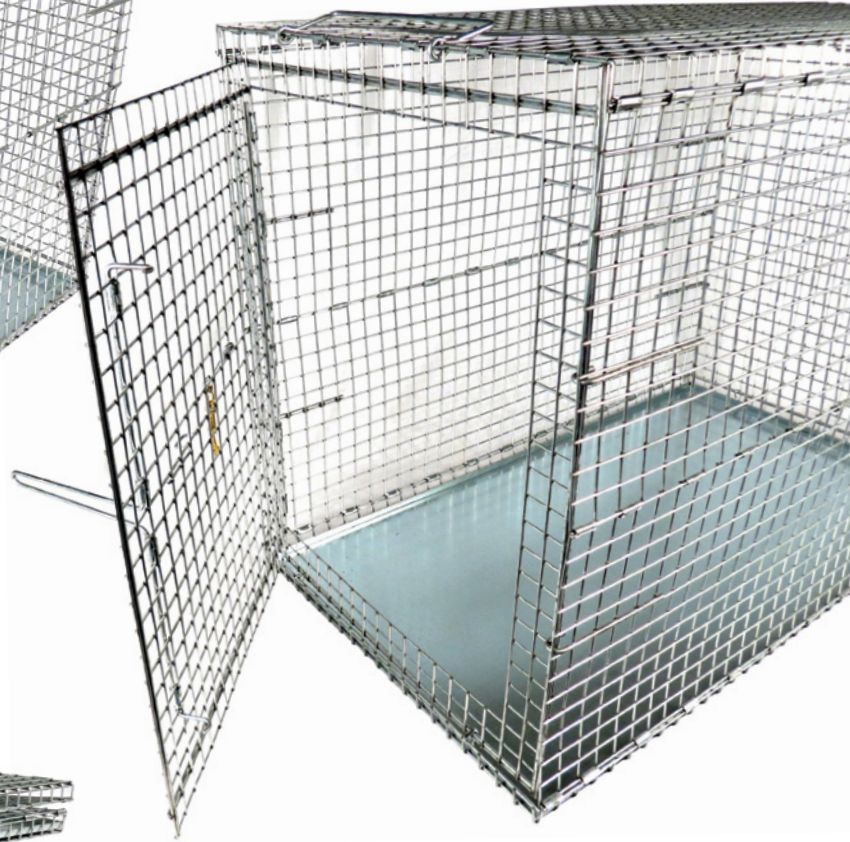

Hinge Style Door Lock



Collapses to Just 3" for Easy Storage

Tomahawk Dog Kennel Crates are professional quality heavy duty crates for safely transporting dogs. They feature a bottom tray for feet comfort, hinge locking door and strong 1 x 1 - 12ga wire mesh. These crates are available in non-collapsing rigid models and also collapsible models for easy storage. Custom sizes can also be made upon request.

Model	Description	L - W - H	Construction	Wt	Price	6+
TK362026C	Collapsible Tomahawk Dog Kennel Crate	36 x 20 x 26	1 x 1 - 12 gauge	28 lbs	\$190.00	\$171.00
TK362026	Non-Collapsible Dog Kennel Crate	36 x 20 x 26	1 x 2 - 12 gauge	28 lbs	\$170.00	\$153.00

Trap Dividers

Trap Dividers allow you to confine animals in a trap by simply sliding it down from the top or through the side of the trap.

Use the divider to isolate the animal, then open the door and replace food and water. Close the door and remove the divider.

They also make it easy to release trapped animals from traps without easy release doors. Isolate the animal with the divider near the back of the trap, open and secure the trap door, and pull the divider to allow the animal to exit the trap.

Tomahawk Trap Dividers come in a variety of sizes to fit nearly all traps and cages. There are two categories of dividers. Standard dividers are constructed from 6 gauge steel rod, and heavy duty dividers are constructed from heavier 1/4" steel rod.

POWDER COAT FINISH
Available for an additional 15%
Black only



Standard Trap Dividers - 6 Gauge Steel Rod

Model	Description	Traps to Use With Divider	Construction	Wt	Price	6+
TD09	9" Divider	For 9" Wide and Smaller Traps and Cages	6 Gauge Steel Rod	2 lbs	\$18.20	\$16.38
TD10	10" Divider	For 10" Wide and Smaller Traps and Cages	6 Gauge Steel Rod	2 lbs	\$19.55	\$17.60
TD12	12" Divider	For 12" Wide and Smaller Traps and Cages	6 Gauge Steel Rod	3 lbs	\$21.20	\$19.08

Heavy Duty Trap Dividers - 1/4" Steel Rod

Model	Description	Traps to Use With Divider	Construction	Wt	Price	6+
TD09H	9" Divider	For 9" Wide and Smaller Traps and Cages	1/4" Steel Rod	2 lbs	\$20.35	\$18.32
TD10H	10" Divider	For 10" Wide and Smaller Traps and Cages	1/4" Steel Rod	3 lbs	\$21.70	\$19.53
TD12H	12" Divider	For 12" Wide and Smaller Traps and Cages	1/4" Steel Rod	4 lbs	\$23.30	\$20.97
TD15H	15" Divider	For 15" Wide and Smaller Traps and Cages	1/4" Steel Rod	7 lbs	\$26.20	\$23.58
TD20H	20" Divider	For 20" Wide and Smaller Traps and Cages	1/4" Steel Rod	11 lbs	\$28.30	\$25.47

Feral Cat Trap Divider - 1/4" Powder Coated Steel Rod with Locking Clip

Model	Description	Traps to Use With Divider	Construction	Wt	Price	6+
TD12NC	12" Divider	206NC, 606NC, 608NC, 608FN 108, 608, 106, 606	1/4" Powder Coated Steel Rod	3 lbs	\$26.50	\$23.85

Trap Flags and Trap Flag Lights are excellent tools for checking traps when they are in difficult to access locations. They provide a visual alert from a distance with an upright flag and blinking light when your trap has been sprung. The Trap Flag clips on in seconds and can be used with any make or model cage style trap. Trap Flag Light clips directly onto the Trap Flag and blinks red when the flag is upright. Trap Flag Light is excellent for checking traps at night or in dark areas like attics and crawl spaces.



Trap Flag & Trap Flag Light

Model	Description	Construction	Size	Wt	Price	6+
TF100	Trap Flag	Plastic & Steel	20" High	.25 lbs	\$15.85	\$14.27
TF110	Trap Flag Light - attaches to TF100 Trap Flag	Plastic Light	2" High	.1 lbs	\$10.55	\$9.50
TF120	Trap Flag & Light Combo	Plastic & Steel	20" High	.35 lbs	\$23.85	\$21.47

Trap Wraps are made from UV stabilized and corrugated plastic which makes them durable, waterproof, and washable. They are easy to install with no tools required. They are proven to reduce animal stress and injuries. And they protect animals from wind, rain, sun, and other elements. They also hide trapped animals from people who might become alarmed. We'll install Trap Wrap free with the purchase of any corresponding trap. Trap Wraps are very affordable and we strongly recommend permanently attaching them to your traps.



Trap Wraps

Model	Traps to Use With	Construction	L-W-H	Wt	Price	6+
TW102G	5"W x 5"H Traps	Corrugated Plastic	14 x 5 x 4	1 lb.	\$11.65	\$10.49
TW103G	6"W x 6"H Traps	Corrugated Plastic	16 x 6 x 5	1 lb.	\$12.70	\$11.43
TW104G	7"W x 7"H Traps	Corrugated Plastic	17 x 7 x 6	1 lb.	\$14.85	\$13.37
TW105G	Long 7"W x 7"H Traps	Corrugated Plastic	22 x 7 x 6	1 lb.	\$15.90	\$14.31
TW106G	9"W x 9"H Traps	Corrugated Plastic	22 x 9 x 8	1 lb.	\$20.15	\$18.14
TW1010G	10"W x 10"H Traps	Corrugated Plastic	24 x 10 x 9	1 lb.	\$22.25	\$20.03
TW108G	10W x 12"H Traps	Corrugated Plastic	26 x 10 x 11	1 lb.	\$23.30	\$20.97



Made to Order - Our plastic trap covers are made specifically for each model of trap. This ensures an exact fit for handle cut outs and length, height and width of the trap. To select a model # for ordering use the model number of your trap and add the letters PTC in front of them. Example: For trap model 608 the plastic trap cover model would be PTC608. If you don't know your trap model number call us and we can find it for you with some information about your trap.

Protects Animals and People - Plastic trap covers not only calm trapped animals but also shelter them from weather and provide shade from the sun. They also visually hide animals from people and reduce risk of injury to trapped animals and people passing by.

Durable - Constructed from UV stabilized .090 polyethylene these covers will hold up against the elements and last for years.

Plastic Trap Covers - (Made Custom To Fit Any Trap)

Model	Traps to Use With	Construction	L-W-H	Wt	Price	6+
PTC+(Trap Model)	For 5"W x 5"H Traps (Length Custom To Fit Trap)	.090 low density polyethylene	5 x 5	1 lb	\$16.45	\$14.81
PTC+(Trap Model)	For 6"W x 6"H Traps (Length Custom To Fit Trap)	.090 low density polyethylene	6 x 6	2 lbs	\$18.55	\$16.70
PTC+(Trap Model)	For 7"W x 7"H Traps (Length Custom To Fit Trap)	.090 low density polyethylene	7 x 7	3 lbs	\$20.65	\$18.59
PTC+(Trap Model)	For 9"W x 9"H Traps (Length Custom To Fit Trap)	.090 low density polyethylene	9 x 9	4 lbs	\$25.95	\$23.36
PTC+(Trap Model)	For 10"W x 10"H Traps (Length Custom To Fit Trap)	.090 low density polyethylene	10 x 10	4 lbs	\$31.25	\$28.13
PTC+(Trap Model)	For 10"W x 12"H Traps (Length Custom To Fit Trap)	.090 low density polyethylene	10 x 12	5 lbs	\$31.25	\$28.13
PTC+(Trap Model)	For 12"W x 12"H Traps (Length Custom To Fit Trap)	.090 low density polyethylene	12 x 12	5 lbs	\$36.55	\$32.90



Plastic Trap Tags

Plastic trap tags measure 3.75 x 3.75 and are made of UV protected plastic to hold up to the elements. These tags can be easily attached to any trap with zip ties and are an affordable way to ID traps and keep track of trapped animals.

Model	Description	Price	6+
TAG10	TNR Trap Tag	\$1.50	\$1.25
TAG11	Pet Rescue Trap Tag	\$1.50	\$1.25



Tag 1



Tag 2



Tag 3



Tag 4



Tag 5



Tag 6

Customized Trap ID Tag & Pet ID Tags

These tags are made to order customized with names, addresses, phone numbers or any wording of your choice. Trap ID tag comes with two attaching rings and Pet ID tags come with one attaching ring.

 **FREE SHIPPING ON ALL TRAP & PET TAGS**

Model	Description	Price
TAG1	Brass Trap ID Tag	\$4.95
TAG2	Heart Pet ID Tag	\$4.95
TAG3	Circle Pet ID Tag	\$4.95
TAG4	Bone Pet ID Tag	\$4.95
TAG5	Hydrant Pet ID Tag	\$4.95
TAG6	Octagon Pet ID Tag	\$4.95

Tomahawk Wheel Kits

Redesigned for easy installation and disconnect! Wheel axle frame quickly attaches to the trap in seconds with no tools required. Two 10" pneumatic tires can roll over tough terrain and hold up to 600 lbs. allowing you to easily transport captured dogs or other trapped animals.



Wheel Kits

Model	Description	Traps To Use With	Wt	Price
WK4	Wheel Kit for Dog Traps	110A, 110B, 110C, 610A, 610B, 610C, 210A, 210B, 210C	8 lbs	\$60.00



Kennel-Gear Plastic Cage Cups

One quart bowl constructed of dishwasher safe, durable, polypropylene. Comes with a bowl and cage bar mount. The mounting systems works on kennel bars, cages, traps, or chain link fences. You can also mount the surface plate to a solid surface (thumbscrews and back plate are not required when attaching surface mount to a solid surface).

Model	Description	Color	Wt	Price
7100-1	1 Quart Cup w/Cage Bar Mount	Grey	1 lb	\$17.95
7100-7	1 Quart Cup w/Cage Bar Mount	Pink	1 lb	\$17.95
7100-8	1 Quart Cup w/Cage Bar Mount	Purple	1 lb	\$17.95
7100-11	1 Quart Cup w/Cage Bar Mount	Slate Blue	1 lb	\$17.95

Kennel-Gear Stainless Steel Cage Cups

Kennel Bar Mount system and detachable stainless steel bowls. This system allows you to attach the bowl to kennels, cages, traps, chain link fences or solid surfaces (solid surface attachments do not require the thumbscrews or back plate). Once the Kennel Bar Mount has been installed the bowl can easily be inserted into the mount and also removed.

Model	Description	Wt	Price
6001	1 Pint Cup w/Cage Bar Mount	1 lb	\$40.95
6003	1 Pint Double Cup w/Cage Bar Mount	1 lb	\$47.95
6004	1 Quart Cup w/Cage Bar Mount	1 lb	\$47.95
6005	1 Quart Double Cup w/Cage Bar Mount	1 lb	\$50.95

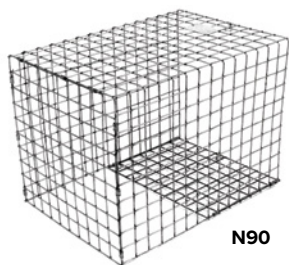
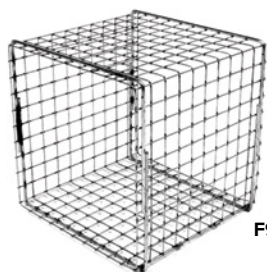
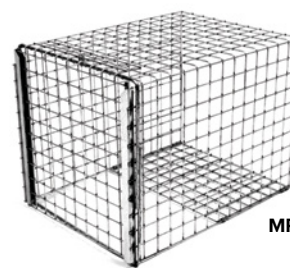
N90

F90

MPC90

Directional Nose Cones

Allow you to make positive sets over animal entry points and dens. They are used in coordination with a trap to give the animal no other option but to enter the trap when it leaves a den or exit point.

Model	For Use With	L - W - H	Construction	Price	6+
N35	Directional Nose Cone for 3x3 Traps	7 x 4 x 4	½ x 1 - 16 gauge	\$16.50	\$14.85
N40	Directional Nose Cone for 4x4 Traps	7 x 4½ x 4½	½ x 1 - 16 gauge	\$16.50	\$14.85
N50	Directional Nose Cone for 5x5 Traps	9 x 5½ x 5½	½ x 1 - 16 gauge	\$18.60	\$16.74
N60	Directional Nose Cone for 6x6 Traps	12 x 7 x 7	1 x 1 - 14 gauge	\$20.50	\$18.45
N70	Directional Nose Cone for 7x7 Traps	12 x 8 x 8	1 x 1 - 14 gauge	\$22.40	\$20.16
N90	Directional Nose Cone for 9x9 Traps	14 x 10 x 10	1 x 1 - 14 gauge	\$25.30	\$22.77
N110	Directional Nose Cone for 10x10 Traps	16 x 11 x 11	1 x 2 - 12 gauge	\$28.15	\$25.34
N120	Directional Nose Cone for 10x12 Traps	18 x 11 x 13	1 x 2 - 12 gauge	\$28.15	\$25.34
N130	Directional Nose Cone for 12x12 Traps	18 x 13 x 13	1 x 2 - 12 gauge	\$31.00	\$27.90

Flush Mount Nose Cones

Allow you to convert your trap into a flush mount trap. A flush mount means the door does not extend past the end of the trap. This allows for flush placement against entry/exit points on structures giving the animal no other option but to enter the trap.

Model	For Use With	L - W - H	Construction	Price	6+
F50	Flush Mount Nose Cone for 5x5 Traps	7 x 5½ x 5½	½ x 1 - 16 gauge	\$18.60	\$16.74
F60	Flush Mount Nose Cone for 6x6 Traps	8 x 7 x 7	1 x 1 - 14 gauge	\$20.50	\$18.45
F70	Flush Mount Nose Cone for 7x7 Traps	8 x 8 x 8	1 x 1 - 14 gauge	\$22.40	\$20.16
F90	Flush Mount Nose Cone for 9x9 Traps	10 x 10 x 10	1 x 1 - 14 gauge	\$25.30	\$22.77
F110	Flush Mount Nose Cone for 10x10 Traps	12 x 11 x 11	1 x 2 - 12 gauge	\$28.15	\$25.34
F120	Flush Mount Nose Cone for 10x12 Traps	12 x 11 x 13	1 x 2 - 12 gauge	\$28.15	\$25.34
F130	Flush Mount Nose Cone for 12x12 Traps	12 x 13 x 13	1 x 2 - 12 gauge	\$31.00	\$27.90

Multi-Purpose Converters

Allow you to convert your trap into a Multi-Purpose Trap for positive sets over den openings or flush against structures.

Model	For Use With	L - W - H	Construction	Price	6+
MPC50	Multi-Purpose Nose Cone for 5x5 Traps	9 x 5½ x 5½	½ x 1 - 16 gauge	\$20.65	\$18.59
MPC60	Multi-Purpose Nose Cone for 6x6 Traps	13 x 7 x 7	1 x 1 - 14 gauge	\$22.80	\$20.52
MPC70	Multi-Purpose Nose Cone for 7x7 Traps	13 x 8 x 8	1 x 1 - 14 gauge	\$24.90	\$22.41
MPC90	Multi-Purpose Nose Cone for 9x9 Traps	14 x 10 x 10	1 x 1 - 14 gauge	\$28.10	\$25.29
MPC110	Multi-Purpose Nose Cone for 10x10 Traps	16 x 11 x 11	1 x 2 - 12 gauge	\$31.25	\$28.13
MPC120	Multi-Purpose Nose Cone for 10x12 Traps	18 x 11 x 13	1 x 2 - 12 gauge	\$31.25	\$28.13
MPC130	Multi-Purpose Nose Cone for 12x12 Traps	18 x 13 x 13	1 x 2 - 12 gauge	\$34.45	\$31.01

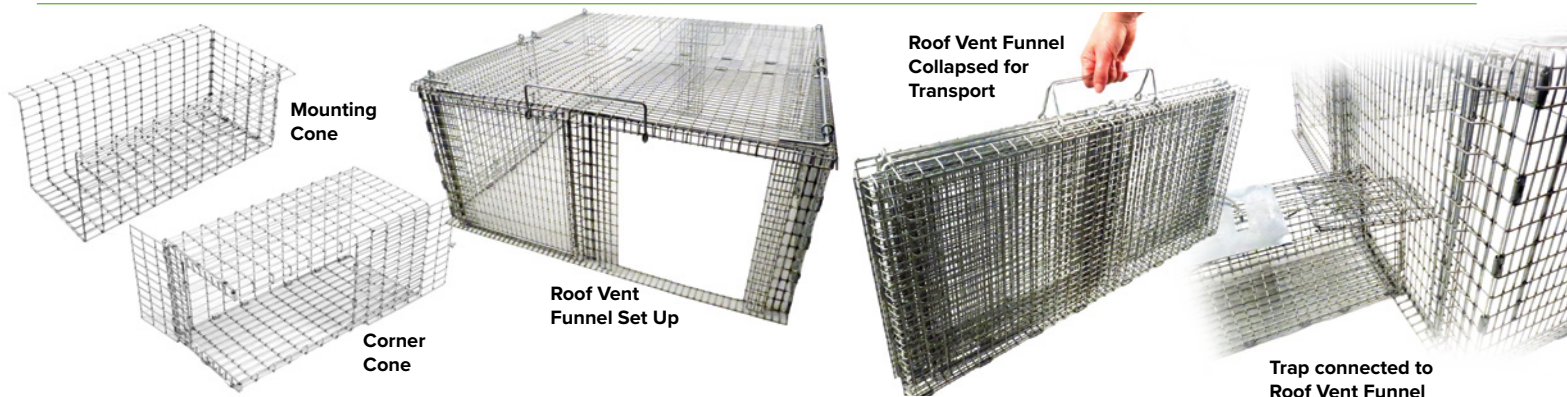

Mounting Cones

Can be used to mount traps or one way excluders under soffits, on rooftops, against walls or even spiked into the ground over animal entry points. These easy to attach cones have a 1" flap on the outside edge for mounting. They fit over the trap and can be extended out past the front of the trap to be used as directional cones for funneling animals into the trap.

Model	Traps to use with Flush Mount Converters	L - W - H	Wt	Price	6+
SC40	E30, E30D, E35, SPT30, SPT35 - 3x3 Traps & Excluders	12 x 4 x 4	1 lbs	\$19.60	\$17.64
SC50	E40, E40D, SPT40, SPT45 - 4x4 Traps & Excluders	12 x 5 x 5	2 lbs	\$19.60	\$17.64
SC60	E50, E50D, SPT50, SPT55, 102, 602, 102F, 602F, 101SS, 102SS, 602SS - 5x5 Traps & Excluders	14 x 6 x 6	3 lbs	\$20.65	\$18.59
SC70	E60, E60D, 103, 603, 103F, 603F, 103SS, 603SS, 104, 202, 202.5, 203, 603 - 6x6 Traps & Excluders	20 x 7 x 7	4 lbs	\$22.80	\$20.52
SC80	E70, E70D, 104.5, 604.5, 105, 605, 105.5, 105SS, 605SS, 105F, 605F, 204 - 7x7 Traps & Excluders	20 x 8 x 8	5 lbs	\$24.90	\$22.41
SC100	E80, E80D, 106, 106.3, 107, 205, 206, 606, 606.3, 106SS, 606SS, 106F, 606F - 9x9 Traps & Excluders	24 x 10 x 10	6 lbs	\$28.10	\$25.29
SC110	1010, 1010F, 1010SS, 6010, 6010F, 6010SS - 10x10 Traps	24 x 11 x 11	6.5 lbs	\$30.20	\$27.18
SC130	108, 608, 108.1, 608.1, 108F, 608F, 108SS, 608SS, 207, 108.6 - 10x12 & 12x12 Traps	26 x 13 x 13	7 lbs	\$31.30	\$28.17

Inside Corner Cones

are used to mount traps or one way excluders on 90 degree inside corners

Model	Traps to use with Flush Mount Converters	L - W - H	Wt	Price	6+
CC40	E30, E30D, E35, SPT30, SPT35 - 3x3 Traps & Excluders	12 x 4 x 4	1 lbs	\$24.40	\$21.96
CC50	E40, E40D, SPT40, SPT45 - 4x4 Traps & Excluders	12 x 5 x 5	1 lbs	\$24.90	\$22.41
CC60	E50, E50D, SPT50, SPT55, 102, 602, 102F, 602F, 101SS, 102SS, 602SS - 5x5 Traps & Excluders	14 x 6 x 6	1 lbs	\$25.45	\$22.91
CC70	E60, E60D, 103, 603, 103F, 603F, 103SS, 603SS, 104, 202, 202.5, 203, 603 - 6x6 Traps & Excluders	20 x 7 x 7	2 lbs	\$26.50	\$23.85
CC80	E70, E70D, 104.5, 604.5, 105, 605, 105.5, 105SS, 605SS, 105F, 605F, 204 - 7x7 Traps & Excluders	20 x 8 x 8	2 lbs	\$31.80	\$28.62
CC100	E80, E80D, 106, 106.3, 107, 205, 206, 606, 606.3, 106SS, 606SS, 106F, 606F - 9x9 Traps & Excluders	24 x 10 x 10	2 lbs	\$37.10	\$33.39
CC110	1010, 1010F, 1010SS, 6010, 6010F, 6010SS - 10x10 Traps	24 x 11 x 11	3 lbs	\$39.75	\$35.78
CC130	108, 608, 108.1, 608.1, 108F, 608F, 108SS, 608SS, 207, 108.6 - 10x12 & 12x12 Traps	26 x 13 x 13	4 lbs	\$42.40	\$38.16

Roof Vent Funnels

Are collapsible funnels that can be attached over roof vents or other roof entry points to funnel animals into multiple attached traps. This funnel is available with two or four openings giving you the option to attach up to four traps at a time over a single entry point. Each opening can also be closed off if only one trap is to be used. Extra door panels can be used to make the openings smaller or larger to accommodate different sized traps. Door panels are available with openings to fit 3x3, 4x4, 5x5, 6x6, 7x7, 9x9, 9x11 Comstock, 10x10 and 10x12 traps or one way excluders. Each unit comes with a shut off panel for extra doors and one set of panels with door openings of your choice. This tool is excellent for reducing repeat trips to a job site by letting you catch multiple animals per set. It collapses to just 4" wide for easy storage and sets up in seconds.

Model	Description	L - W - H	Wt	Price	6+
RVF201	Collapsible 2-Door Roof Vent Funnel	30 x 30 x 13	20 lbs	\$125.00	\$112.50
RVF202	Collapsible 4-Door Roof Vent Funnel	30 x 30 x 13	30 lbs	\$175.00	\$157.50
RVFDOORS	Choice of 2 Extra Door Panels with 3x3, 4x4, 5x5, 6x6, 7x7, 9x9, 9x11 or 10x10 openings 1/2 x 1 - 14 gauge	-	5 lbs	\$20.00	\$18.00



Raccoon Specific
Nose Cone



Collapsible
Nose Cone



Collapsible Nose Cone In Use

The Alkerton Raccoon Nose Cone

is designed specifically to catch raccoon only and prevent cats and skunks from entering the trap. These cones attach easily to the front 12x12 raccoon traps with zip ties or hog rings. The cone features a door that is easy for raccoon to open and enter the trap for bait but nearly impossible to open for cats and skunks. This cone is also collapsible for easy transportation and storage.

Model	For Use With	L - W - H	Construction	Wt	Price	6+
ACC9	Fits 9x9 Traps	12 x 10 x 10	1 x 1 - 12 gauge	3.5 lbs	\$52.95	\$47.66
ACC12	Fits 10x10, 10x11, 12x12 Traps	14 x 13 x 13	1 x 2 - 12 gauge	5.5 lbs	\$58.25	\$52.43

Alkerton Collapsible Nose Cones

are used to create a directional cone on the front of the trap over an animal den openings or entry points on structures.

Model	For Use With	L - W - H	Construction	Wt	Price	6+
CN50	Fits all 5Wx5H Traps	9 x 5½ x 6	½ x 1 - 14 gauge	.75 lbs	\$21.20	\$19.08
CN60	Fits all 6Wx6H Traps	9 x 6½ x 7	½ x 1 - 14 gauge	1 lbs	\$23.85	\$21.47
CN70	Fits all 7Wx7H Traps	11 x 8 x 9	1 x 1 - 14 gauge	1.25 lbs	\$26.50	\$23.85
CN90	Fits all 9Wx 9H Traps	14 x 10 x 11	1 x 1 - 14 gauge	1.75 lbs	\$29.15	\$26.24
CN100	Fits all 10Wx10H Traps	14 x 11 x 12	1 x 2 - 12 gauge	2.25 lbs	\$31.80	\$28.62
CN120	Fits all 10Wx12H Traps	14 x 11x 14	1 x 2 - 12 gauge	2.5 lbs	\$34.45	\$31.01
CN130	Fits all 12Wx12H Traps	18 x 13 x 14	1 x 2 - 12 gauge	3.5 lbs	\$37.10	\$33.39

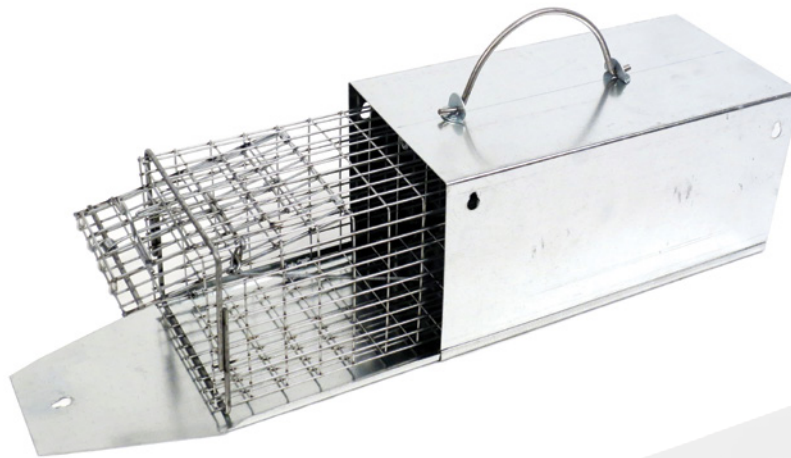

Trap Docks

Attach to structures then traps are set inside the dock with bait to catch animals. These docks make it possible to set traps in difficult places such as slanted rooftops. They also protect the bait and trapped animals from the elements.

Model	Description	L - W - H	Construction	Wt	Price
TD1800	Fits models 102, 602, 201, 101SS, 102SS, 602SS	26 x 6 x 6	Sheet Metal	3 lbs	\$35.00
TD3000	Fits all raccoon sized traps 10x12 & 10x10	36 x 12 x 13	Sheet Metal	12 lbs	\$80.00

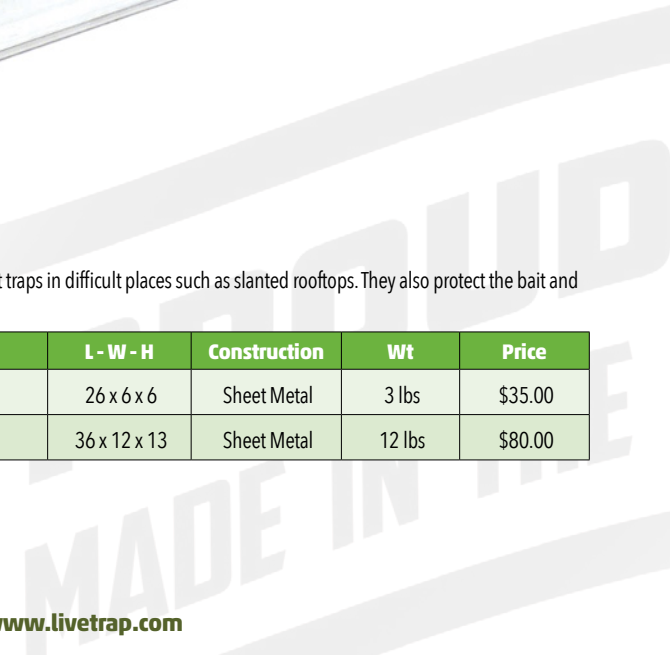

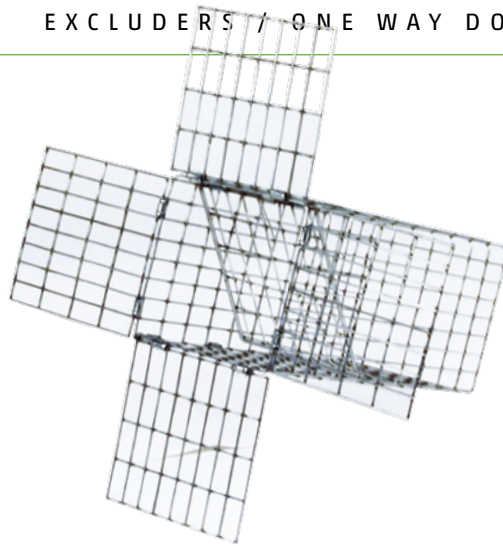

Excluders are included with Squirrel Packs to trap animals rather than exclude them. Refer to page 35 for Squirrel Packs.

Excluders with One Way Door

Our excluders are designed to let animals remove themselves from unwanted areas. Excluders have mounting wings which allow them to be attached directly over the animals' entry/exit hole. The one way door lets animals exit, but prevents them from returning.

Model	Suggested Target Animal Size	L - W - H	Construction	Wt	Price	6+
E30	Chipmunks, Flying Squirrels, Small Rodents	11 x 3 x 3	½ x 1 - 14 gauge	1 lb	\$24.40	\$21.96
E35	Chipmunks, Flying Squirrels, Small Rodents	11 x 3.5 x 3.5	½ x 1 - 14 gauge	1 lb	\$24.90	\$22.41
E40	Squirrels, Rats	11 x 4 x 4	½ x 1 - 14 gauge	1 lb	\$25.45	\$22.91
E50	Squirrels, Rats	12 x 5 x 5	½ x 1 - 14 gauge	1 lb	\$26.50	\$23.85
E60	Skunks, Cats, Rabbits, Opossum	12 x 6 x 6	1 x 1 - 14 gauge	2 lbs	\$31.80	\$28.62
E70	Skunks, Cats, Rabbits, Opossum	12 x 7 x 7	1 x 1 - 14 gauge	2 lbs	\$37.10	\$33.39
E80	Skunks, Feral Cats, Raccoon	14 x 8 x 8	1 x 1 - 14 gauge	3 lbs	\$42.40	\$38.16
E80CG	Raccoon Excluder with Guard Panel	14 X 8 X 8	1 X 1 - 14 gauge	4 lbs	\$47.70	\$42.93

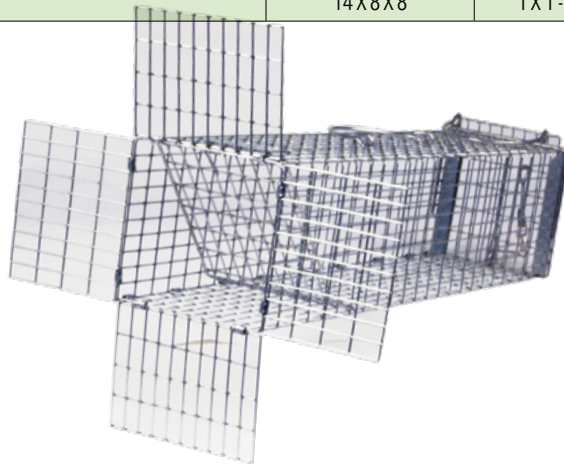

Excluder Traps with One Way Door and Easy Release Door

The rear door turns excluders into repeating traps. Simply remove the rear door to use this as a true excluder, or put the door in place to trap excluded animals.

Model	Suggested Target Animal Size	L - W - H	Construction	Wt	Price	6+
E30D	Chipmunks, Flying Squirrels, Small Rodents	19 x 3 x 3	½ x 1 - 14 gauge	1 lb	\$36.55	\$32.90
E40D	Squirrels, Rats	26 x 4 x 4	½ x 1 - 14 gauge	2 lbs	\$38.15	\$34.34
E50D	Squirrels, Rats	26 x 5 x 5	½ x 1 - 14 gauge	3 lbs	\$39.75	\$35.78
E60D	Skunks, Cats, Rabbits, Opossum	26 x 6 x 6	1 x 1 - 14 gauge	3 lbs	\$47.70	\$42.93
E70D	Skunks, Cats, Rabbits, Opossum	30 x 7 x 7	1 x 1 - 14 gauge	4 lbs	\$55.65	\$50.09
E80D	Skunks, Feral Cats, Raccoon	30 x 8 x 8	1 x 1 - 14 gauge	6 lbs	\$63.60	\$57.24

**Squirrel Packs-
Squirrel Pack Removal Systems**

Let the critters remove themselves with this system. It's perfect for squirrels and small rodent size animals. And it's extremely simple to use and very effective. Squirrel packs consist of one excluder and two repeating traps. Attach the excluder over the animals den opening with the mounting wings. Slide the repeating trap over the excluder and hook into place. As critters exit, the excluder will direct them into the repeating trap. There are two types of squirrel packs available, one with two trap doors and the other with one trap door and an easy release rear door.

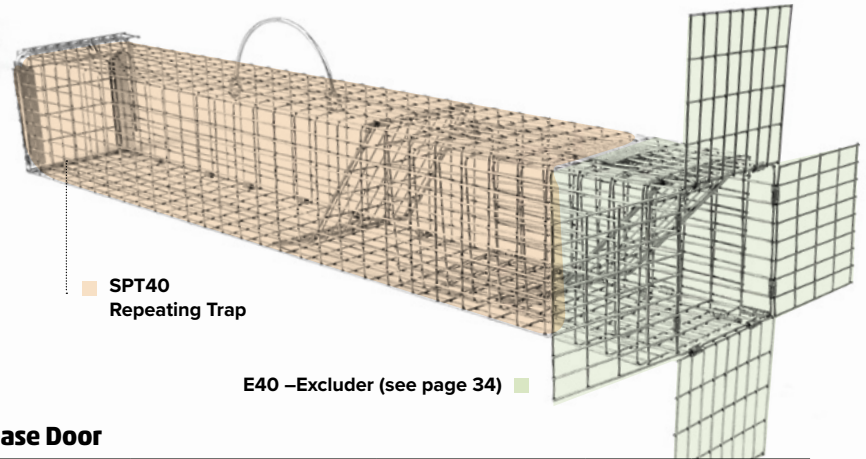

3 Piece Squirrel Pack With One Trap Door And Easy Release Door

Model	Description	Squirrel Pack Includes	Construction	Wt	Price	6+
SP30	Small - 3 x 3	1-E30 and 2-SPT30	1/2 x 1 - 14 gauge	3 lbs	\$73.17	\$65.85
SP40	Medium - 4 x 4	1-E40 and 2-SPT40	1/2 x 1 - 14 gauge	4 lbs	\$79.79	\$71.81
SP50	Large - 5 x 5	1-E50 and 2-SPT50	1/2 x 1 - 14 gauge	6 lbs	\$85.23	\$76.71

3 Piece Squirrel Pack With Two Trap Doors

Model	Description	Squirrel Pack Includes	Construction	Wt	Price	6+
SP35	Small - 3 x 3	1-E30 and 2-SPT35	1/2 x 1 - 14 gauge	3 lbs	\$73.17	\$65.85
SP45	Medium - 4 x 4	1-E40 and 2-SPT45	1/2 x 1 - 14 gauge	4 lbs	\$79.79	\$71.81
SP55	Large - 5 x 5	1-E50 and 2-SPT55	1/2 x 1 - 14 gauge	6 lbs	\$85.23	\$76.71

Deluxe Squirrel Pack

Includes one excluder, one soffit cone, one inside corner cone, and two repeating traps. This versatile multiple catch system allows you to trap or exclude the entire infestation from den openings located virtually anywhere, including vertical surfaces, inside corners, or overhanging structures. Make short work of any squirrel job with this incredible system.

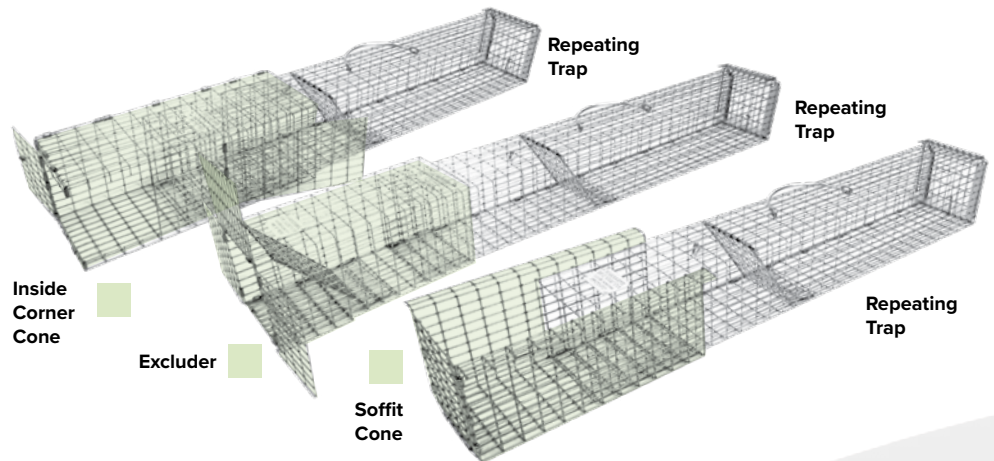

5 Piece Deluxe Squirrel Packs With One Trap Door And Easy Release Door

Model	Description	Squirrel Pack Includes	Construction	Wt	Price	6+
DSP30	Small - 3 x 3	1-E30, 2-SPT30, 1-SC40, 1-CC40	1/2 x 1 - 14 gauge	3 lbs	\$112.77	\$101.49
DSP40	Medium - 4 x 4	1-E40, 2-SPT40, 1-SC50, 1-CC50	1/2 x 1 - 14 gauge	4 lbs	\$119.84	\$107.85
DSP50	Large - 5 x 5	1-E50, 2-SPT50, 1-SC60, 1-CC60	1/2 x 1 - 14 gauge	6 lbs	\$126.72	\$114.05

5 Piece Deluxe Squirrel Packs With Two Trap Doors

Model	Description	Squirrel Pack Includes	Construction	Wt	Price	6+
DSP35	Small - 3 x 3	1-E30, 2-SPT35, 1-SC40, 1-CC40	1/2 x 1 - 14 gauge	3 lbs	\$112.77	\$101.49
DSP45	Medium - 4 x 4	1-E40, 2-SPT45, 1-SC50, 1-CC50	1/2 x 1 - 14 gauge	4 lbs	\$119.84	\$107.85
DSP55	Large - 5 x 5	1-E50, 2-SPT55, 1-SC60, 1-CC60	1/2 x 1 - 14 gauge	6 lbs	\$126.72	\$114.05

Repeating Traps - used with Squirrel Packs

Repeating Traps are used with excluders to create Squirrel Packs. They are simply repeating traps that slide over excluders. Two repeating trap are included with the purchase of a squirrel pack, however, these repeating traps can also be purchased separately. There are two types of repeating traps available, one with two trap doors and the other with one trap door and an easy release rear door.

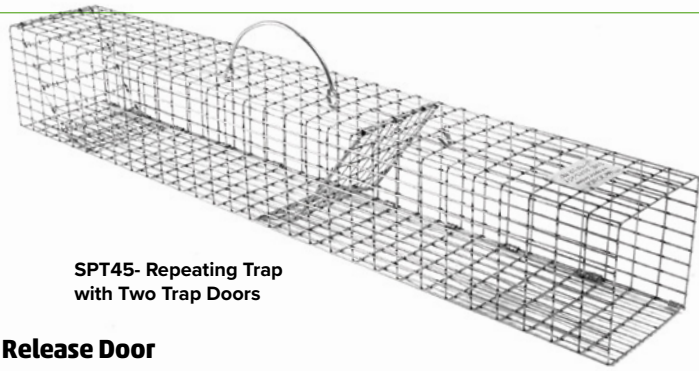

SPT45- Repeating Trap with Two Trap Doors

Repeating Traps with One Recessed Trap Door and Easy Release Door

Model	Description	L - W - H	Construction	Wt	Price	6+
SPT30	Repeating Trap For Use With 3 x 3 Excluders	26 x 3½ x 3½	½ x 1 - 14 gauge	2 lbs	\$28.45	\$25.61
SPT40	Repeating Trap For Use With 4 x 4 Excluders	30 x 4½ x 4½	½ x 1 - 14 gauge	3 lbs	\$31.60	\$28.44
SPT50	Repeating Trap For Use With 5 x 5 Excluders	36 x 5½ x 5½	½ x 1 - 14 gauge	4 lbs	\$34.10	\$30.69

Repeating Traps with Two Trap Doors Featuring One Recessed Door

Model	Description	L - W - H	Construction	Wt	Price	6+
SPT35	Repeating Trap For Use With 3 x 3 Excluders	26 x 3½ x 3½	½ x 1 - 14 gauge	2 lbs	\$28.45	\$25.61
SPT45	Repeating Trap For Use With 4 x 4 Excluders	30 x 4½ x 4½	½ x 1 - 14 gauge	3 lbs	\$31.60	\$28.44
SPT55	Repeating Trap For Use With 5 x 5 Excluders	36 x 5½ x 5½	½ x 1 - 14 gauge	4 lbs	\$34.10	\$30.69

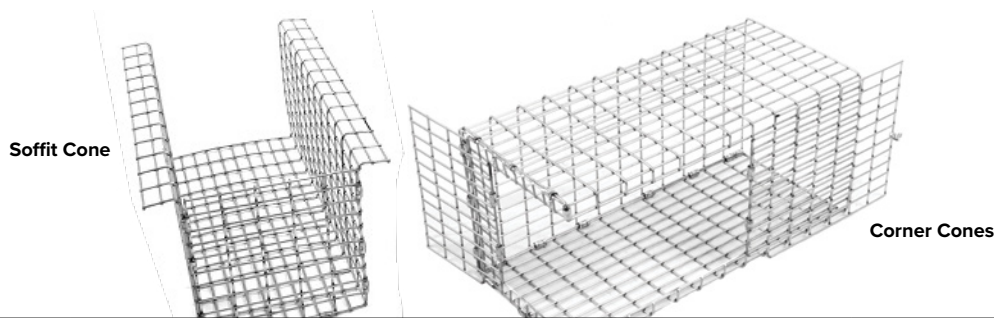

Soffit Cone

Corner Cones

Soffit Cones

Model	L - W - H	Traps To Use With Soffit Cones On Overhanging Surfaces	Construction	Wt	Price	6+
SC40	12 x 4 x 4	E30, E30D, E35, SPT30, SPT35	½ x 1 - 14 gauge	1 lb	\$19.60	\$17.64
SC50	12 x 5 x 5	E40, E40D, SPT40, SPT45	½ x 1 - 14 gauge	2 lbs	\$19.60	\$17.64
SC60	14 x 6 x 6	102, 602, S50, E50, E50D, SPT50, SPT55, 102, 602, 102F, 602F, 201, 101SS, 102SS, 602SS,	½ x 1 - 14 gauge	3 lbs	\$20.65	\$18.59
SC70	20 x 7 x 7	103, 603, 103F, 603F, 103SS, 603SS, 104, 202, 202.5, 203, 603, E60, E60D	1 x 1 - 14 gauge	4 lbs	\$22.80	\$20.52
SC80	20 x 8 x 8	104.5, 604.5, 105, 605, 105.5, 105SS, 605SS, 105F, 605F, 204, S70, E70, E70D	1 x 1 - 14 gauge	5 lbs	\$24.90	\$22.41
SC100	24 x 10 x 10	106, 106.3, 107, 205, 206, 606, 606.3, 106SS, 606SS, 106F, 606F, S90, E80, E80D	1 x 1 - 14 gauge	6 lbs	\$28.10	\$25.29
SC110	24 x 11 x 11	1010, 1010F, 6010, 6010F, 1010SS, 1010SS-F, 6010SS, 6010SS-F	1 x 1 - 14 gauge	6 lbs	\$30.20	\$27.18
SC130	26 x 13 x 13	108, 608, 108.1, 608.1, 108F, 608F, 108SS, 608SS, 207, 108.6	1 x 2 - 12 gauge	7 lbs	\$31.30	\$28.17

Corner Cones for Inside 90 Degree Corners

Model	L - W - H	Traps To Use With Corner Cones	Construction	Wt	Price	6+
CC40	12 x 4 x 4	E30, E30D, E35, SPT30, SPT35	½ x 1 - 14 gauge	1 lb	\$24.40	\$21.96
CC50	12 x 5 x 5	E40, E40D, SPT40, SPT45	½ x 1 - 14 gauge	1 lb	\$24.90	\$22.41
CC60	14 x 6 x 6	102, 602, S50, E50, E50D, SPT50, SPT55, 102, 602, 102F, 602F, 201, 101SS, 102SS, 602SS	½ x 1 - 14 gauge	1 lb	\$25.45	\$22.91
CC70	20x 7 x 7	103, 603, 103F, 603F, 103SS, 603SS, 104, 202, 202.5, 203, 603, E60, E60D	1 x 1 - 14 gauge	2 lbs	\$26.50	\$23.85
CC80	20 x 8 x 8	104.5, 604.5, 105, 605, 105.5, 105SS, 605SS, 105F, 605F, 204, S70, E70, E70D	1 x 1 - 14 gauge	2 lbs	\$31.80	\$28.62
CC100	24 x 10 x 10	106, 106.3, 107, 205, 206, 606, 606.3, 106SS, 606SS, 106F, 606F, S90, E80, E80D	1 x 1 - 14 gauge	2 lbs	\$37.10	\$33.39
CC110	24 x 11 x 11	1010, 1010F, 6010, 6010F, 1010SS, 1010SS-F, 6010SS, 6010SS-F	1 x 1 - 14 gauge	3 lbs	\$39.75	\$35.78
CC130	26 x 13 x 13	108, 608, 108.1, 608.1, 108F, 608F, 108SS, 608SS, 207, 108.6	1 x 2 - 12 gauge	4 lbs	\$42.40	\$38.16

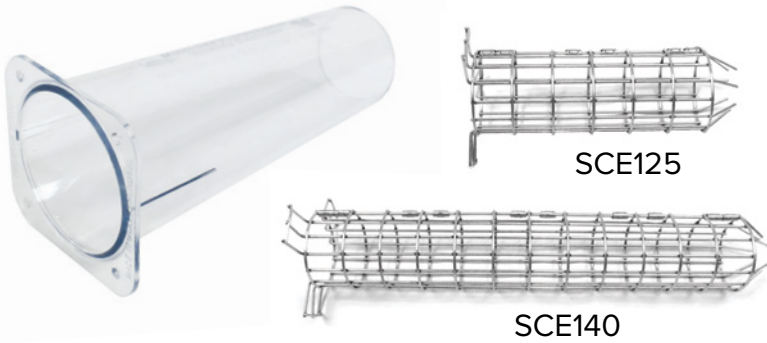

Bat Cones are designed to exclude bats and flying squirrels from homes. Seal all other entry points before installing Bat Cones. Bats are able to exit through the funnel but are unable to gain re-entry. After all animals have exited the home remove the cone and seal the exit point.

Squirrel Cone Excluders are designed to exclude squirrels from homes and other structures. Attach over entry point on structure and seal all other entry points. Squirrels are able to exit the cone but are unable to gain re-entry. After all squirrels have exited remove cone and seal exit point.

Bat cones

Model	Description	L - W - H	Construction	Wt	Price
BCCNR	Bat Cone for Inside Corners	6 x 1.5	Plastic	.15 lb	\$12.95
BCC	Bat Cone with Round Base	6 x 1.5	Plastic	.15 lb	\$12.95
BCSB	Bat Cone with Square Base	6 x 1.5	Plastic	.15 lb	\$12.95
BCO	Bat Cone with Oval Base and Cone	6 x 1.5	Plastic	.15 lb	\$12.95
BCVF	Flexible Vinyl Flange for all Bat Cones	6 x 6	Plastic	.1 lb	\$4.95
BCMF	Flexible 1/4" Mesh Flange for all Bat Cones	7 x 7	1/4" wire mesh	.1 lb	\$4.95

Squirrel Cone Excluders - Standard 16 Ga. Or Heavy Duty 14 Ga

Std Model	HD Model	L - W - H	Description	Construction	Std Price	Std 6+	HD Price	Hd 6+
SCE115	SCE105	7 X 3.5	Grey Squirrel Cone - Short	1/2 x 1 - (Std 16 gauge)(HD 14 gauge)	\$21.15	\$19.04	\$26.45	\$23.81
SCE120	SCE110	12 x 3.5	Grey Squirrel Cone - Long	1/2 x 1 - (Std 16 gauge)(HD 14 gauge)	\$26.45	\$23.81	\$31.75	\$28.58
SCE135	SCE125	7 x 2	Red & Flying Squirrel Cone - Short	1/2 x 1 - (Std 16 gauge)(HD 14 gauge)	\$15.85	\$14.27	\$17.95	\$16.16
SCE140	SCE130	12 x 2	Red & Flying Squirrel Cone - Long	1/2 x 1 - (Std 16 gauge)(HD 14 gauge)	\$19.05	\$17.15	\$21.15	\$19.04

Ridge-Guard

Professional quality pre-formed metal screen installed over the ridge vent on houses to prevent squirrels, mice, stinging insects, birds and other wildlife from damaging ridge vents and entering homes.

Model	Description	Price
Ridge-Guard	160 linear feet of Ridge-Guard + 200 mounting screws.	\$472.00



Critter Pricker

Is a cost-effective prevention tool for raccoons and other nuisance animals. The strips are made of strong polypropylene plastic and prevent animals from entering unwanted areas such as pools, trash cans, feeders, and attics. The patented interlocking snap and hook design strips can be connected side by side and end to end. Once wildlife touches the Critter Pricker, the uncomfortable feel of the pointed cones deters animals from going to these preferred areas while leaving the animal safe and unharmed. The base of the strips are 1.5" wide and can be fastened to multiple surfaces using a variety of materials such as screws, adhesives, and even zip ties.

Model	Description	Piece Size	Quantity	Coverage	Price	6+
CP100	Critter Pricker Animal Deterrent	18" L x 1 1/2" W per piece	10 Pieces per box	3 Sq. Ft.	\$32.99	\$29.69

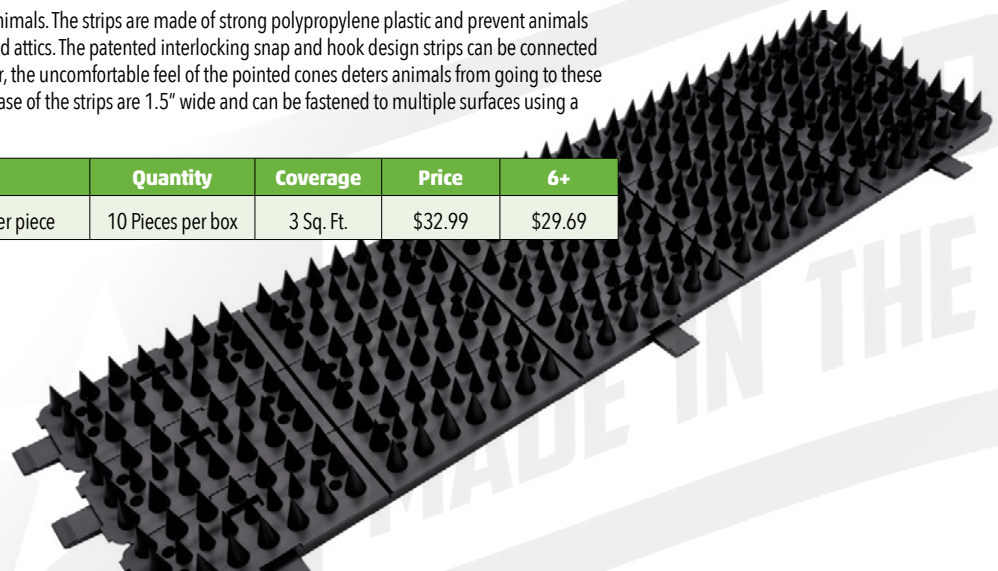



HY-C Chimney Covers

Installed over single or multi-flue chimney to prevent animal entry. They are available in black painted galvanized steel, stainless steel and copper.

Item	Sizes	Styles	Prices
Single Flue Chimney Covers	From 9" x 9" up to 20" x 20"	Black Painted Galvanized Steel, Stainless Steel & Copper	Call or View Online
Multi-Flue Chimney Covers	From 10" x 10" up to 17" x 64"	Black Painted Galvanized Steel, Stainless Steel & Copper	Call or View Online

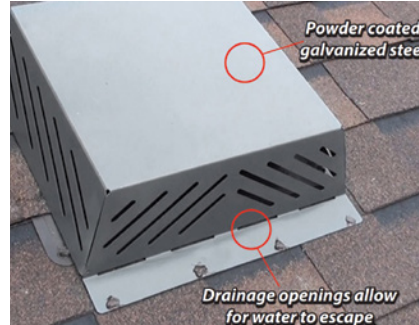

Roof Vent Covers

Installed over roof vents to prevent animal entry. These vent covers are made of galvanized or stainless steel.

Item	L-W-H	Painted Galvanized Steel Price	Stainless Steel Price
Small Roof Vent Cover	7 x 7 x 9	\$17.50	\$24.00
Small Roof Vent Cover	11x11 x 13	\$25.00	\$36.00
Roof Vent Cover - Low Profile	16 x 16 x 5	\$25.00	\$44.25
VentGuard Plus – Professional Vent Cover	16.5 x 16.5 x 5	\$75.00	n/a
Power Roof Vent Cover	25 x 25 x 12	\$30.00	\$66.50
Power Roof Vent Cover - Low Profile	25 x 25 x 6	n/a	\$66.50
Power Roof Vent Cover	30 x 30 x 12	\$42.75	\$99.00

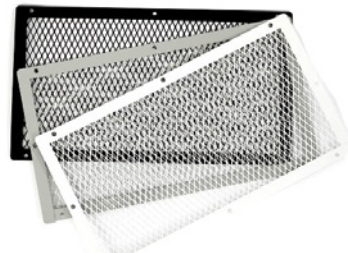

Soffit & Foundation Vent Covers

Installed over soffit and foundation vents to prevent animal entry. These covers come in black, gray or white and are made of galvanized or stainless steel.

Item	L-W	Painted Galvanized Stainless Steel Price	Painted Stainless Steel Price
Soffit Vent Cover	4x16	\$16.00	\$20.00
10 Pack Soffit Vent Covers	4x16	\$96.00	\$147.00
Foundation Vent Cover	10x18	\$20.00	\$25.00
10 Pack Foundation Vent Covers	10x18	\$123.00	\$176.50



DFR6



DWV4 - Flush Mount Dryer Vent Cover

Defender Vent Covers

Professional quality wall vent covers.

Model	Description	Wt	Price	6+
DWV4	The Defender Flush Mount Dryer Vent - 4" - White, Tan or Brown	.75	\$26.30	23.67
DFR6	The Defender Vent Cover - 6.5" - White, Tan or Brown	1 lbs	\$23.95	\$21.56
DFR8	The Defender Vent Cover - 8" - White, Tan or Brown	1.5 lbs	\$24.95	\$22.46
DFR11	The Defender Vent Cover - 11.5" ID, Hinged Bottom - White	3 lbs	\$29.95	\$26.96



Xcluder Strip



Xcluder Sticky Back Strip

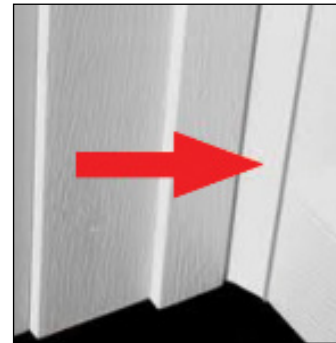

Xcluder Garage Door Rodent Shield

Xcluder Rodent Prevention Products

Xcluder products are designed to prevent mice and other small rodents from entering your house. They are made of anti-chew rodent resistant materials and are used to fill small cracks and crevices and construction gaps on structures.

Model	Description	Price
162706	Xcluder 4"inch wide x 10' ft long roll - 1 Roll	\$24.50
162707	Xcluder 4" inch wide x 10' ft long roll - Case of 5 Rolls	\$116.95
162720	Xcluder Strips, 1" wide x 4' ft long - Case of 36 strips	\$115.95
162715	Xcluder Blocks, 2"x2"x7.5" - Case of 144 Blocks	\$250.00
162715-6	Xcluder Blocks, 2"x2"x7.5" - Bag of 6 blocks	\$20.00
162715-12	Xcluder Blocks, 2"x2"x7.5" - Bag of 12 blocks	\$35.00
162800	Xcluder sticky backed wrap, 2" x 10' ft roll - 2 Rolls	\$59.95
162801	Xcluder sticky backed wrap, 4" x 10' ft roll - 1 Roll	\$47.95
162802	Xcluder sticky backed wrap, 8" x 10' ft roll - 1 Roll	\$81.95
162940	Garage Door Rodent Shields, 2 Shields per pack - 1 Pack	\$8.91
162946	Garage Door Rodent Shields, 2 Shields per pack, Case of 25 Packs	\$205.00



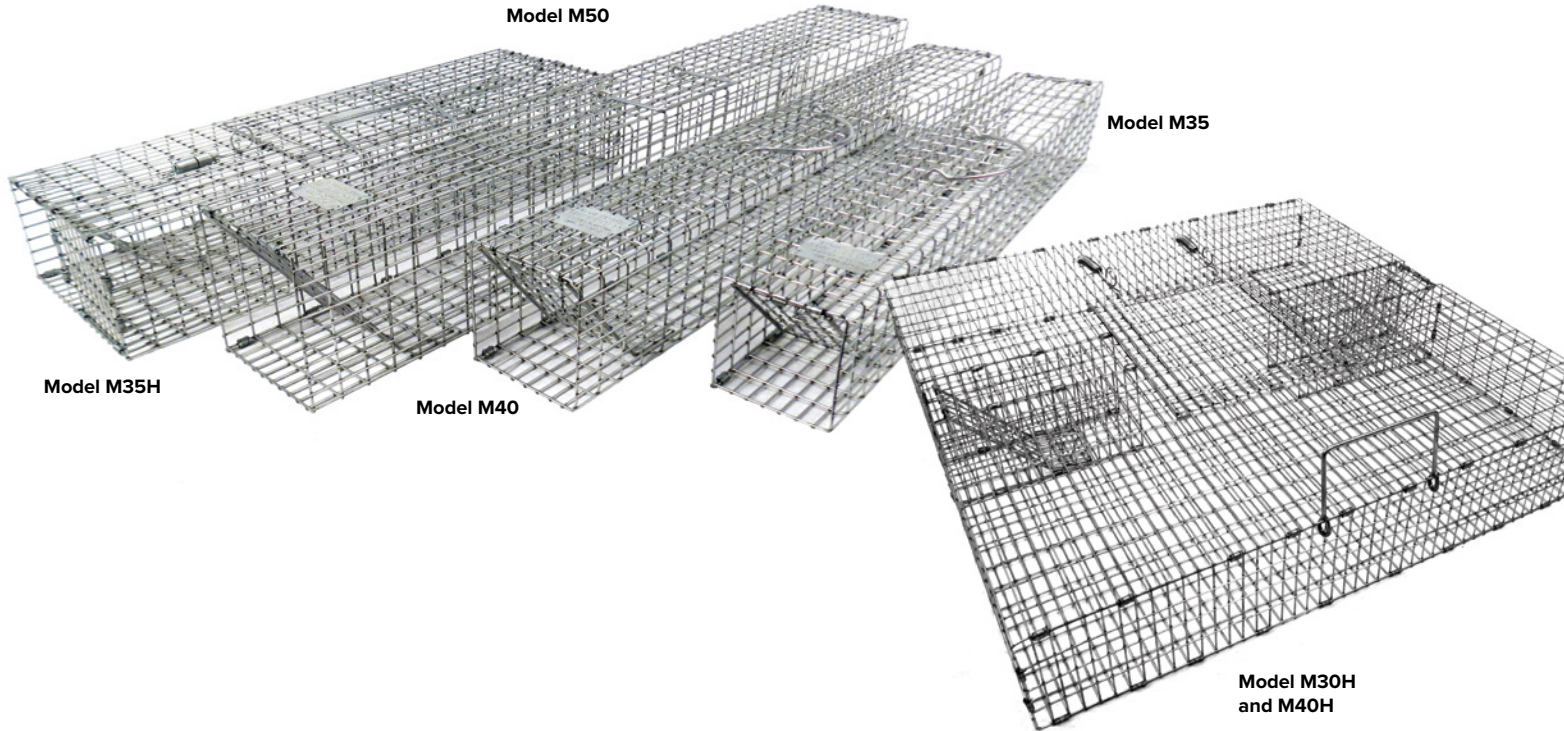

Multiple Catch Traps – Can Hold 4+ Rodents At Once

These traps feature heavy duty galvanized wire mesh frames and spring loaded trap doors at both ends. The doors are designed to allow animals to easily enter the trap and to prevent escape.

Model	Description	L - W - H	Construction	Wt	Price	6+
M35	Double Door Small Rodent Trap	26 x 3 1/2 x 3 1/2	1/2 x 1 - 14 gauge	2 lbs	\$28.45	\$25.61
M40	Double Door Medium Rodent Trap	30 x 4 x 4	1/2 x 1 - 14 gauge	2 lbs	\$31.30	\$28.17
M50	Double Door Large Rodent Trap	36 x 5 x 5	1/2 x 1 - 14 gauge	3 lbs	\$34.10	\$30.69

Multiple Catch Traps With Large Holding Area – Can Hold 10+ Rodents At Once

These traps have the same features as the multiple catch traps described above, however, they are larger with a holding area designed for 10 or more rodents at one time.

Model	Description	L - W - H	Construction	Wt	Price	6+
M30H	Multiple Catch Trap with 3" Doors and Large Holding Area	24 x 24 x 4	1/2 x 1 - 14 gauge	6 lbs	\$63.35	\$57.02
M35H	Multiple Catch Trap with 3 1/2" Doors and Large Holding Area	26 x 8 x 4	1/2 x 1 - 14 gauge	4 lbs	\$63.35	\$57.02
M40H	Multiple Catch Trap with 4" Doors and Large holding Area	24 x 24 x 4	1 x 1 - 14 gauge	6 lbs	\$63.35	\$57.02

Single Set, Flush Mount, Repeating Traps (Simple Traps)

Single set repeating traps operate as multiple catch traps with a swinging spring loaded door. These traps are equipped with a trip pan for a single set but after an animal is caught more may enter the trap by pushing in the repeating door from the outside.

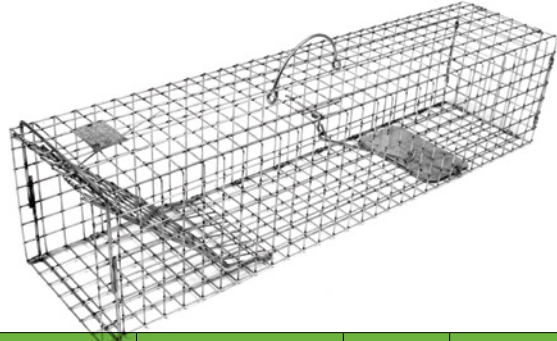

Model	Description	L - W - H	Construction	Wt	Price	6+
S50	Chipmunks, Squirrels	24 x 5 x 5	½ x 1 - 16 gauge	2 lbs	\$31.55	\$28.40
S70	Opossum, Rabbits, Skunks	30 x 7 x 7	1 x 1 - 14 gauge	4 lbs	\$38.95	\$35.06
S90	Cats, Rabbits, Skunks	32 x 9 x 9	1 x 1 - 14 gauge	5 lbs	\$47.45	\$42.71
S3PACK	One of Each Size Above	See Above	See Above	11 lbs	\$106.16	\$95.54

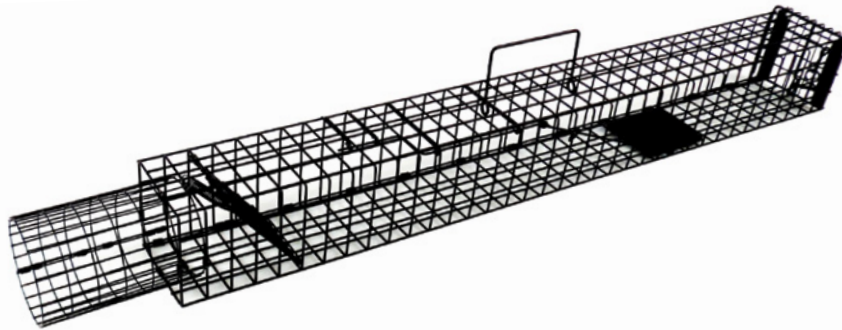

Tomahawk Ferret Trap

Designed with input from the USDA and national park service at Badlands National Park. Black footed ferrets are natural predators of prairie dogs and are an essential part of the ecosystem to keep prairie dogs from overpopulation. The ferret trap was designed to safely catch black footed ferrets for repopulation efforts of the Badlands National Park area.

Model	L-H-W	Description	Construction	Wt	Price	6+
4436	36 x 4 x 4	Ferret trap with 6" long funnel on front end.	1 x 1 - 12 gauge	4 lbs	\$68.90	\$62.01

Ground Hugger Multiple Catch Traps

Positive set for chipmunks, gophers, and ground squirrels. Place directly over the animal's burrow, press the protruding U-Bars firmly into the ground to secure the Ground Hugger in place and let the animals trap themselves as they exit their dens. These traps also feature an easy release rear door.

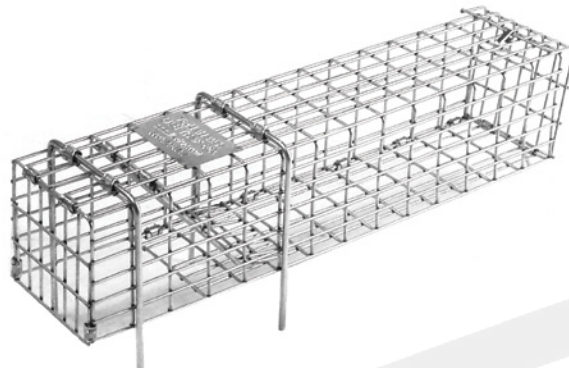

Model	Suggested Target Animal Size	L - H - W	Construction	Wt	Price	6+
G100	Chipmunks, Small Rodents	16 x 3 x 3	½ x 1 - 16 gauge	1 lb	\$28.35	\$25.52
G110	Chipmunks, Ground Squirrels	24 x 4 x 4	½ x 1 - 16 gauge	2 lbs	\$31.55	\$28.40

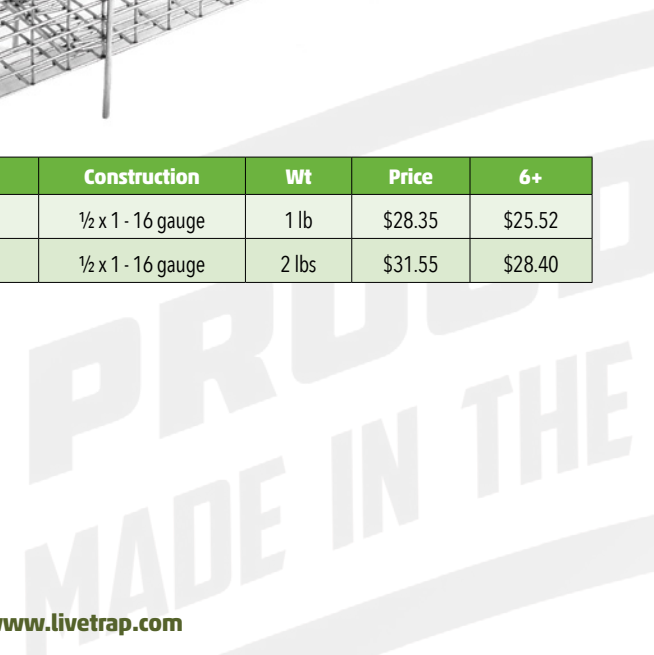

H.B. SHERMAN TRAPS

PROTECTING LIFE BY DESIGN SINCE 1955

Since 1955 H.B. Sherman Traps have been the worldwide standard in sheet metal live animal traps, helping facilitate small mammal research in a safe, environmentally friendly way. They have a sensitive trip mechanism to catch lightweight animals like chipmunks, mice, voles, flying squirrels, rats, shrews, ground squirrels, and so much more.

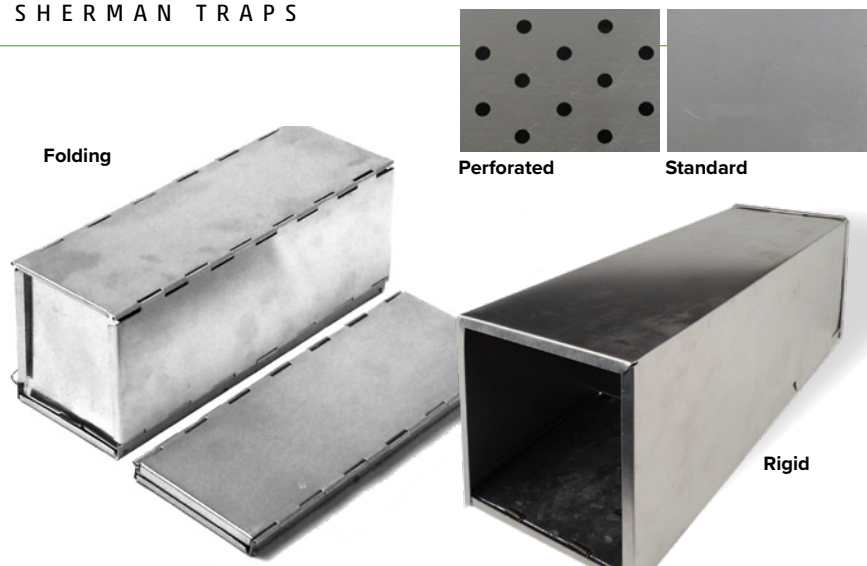

Rigid Sherman Traps

STD Model	Perf Model	L - W - H	Construction	STD	STD 6+	Perf	Perf 6+
SNA	SNA-P	6.5 x 2 x 2.5	.020 Aluminum	\$19.47	\$18.50	\$21.12	\$20.06
SNG	SNG-P	6.5 x 2 x 2.5	30 Gauge Galvanized	\$19.04	\$18.09	\$20.69	\$19.66
SNATDG	SNATDG-P	6.5 x 2 x 2.5	.020 Aluminum Body with Galv Treadles & Doors	\$19.24	\$18.28	\$20.89	\$19.84
LNA	LNA-P	9 x 3 x 3.5	.020 Aluminum	\$23.11	\$21.96	\$24.76	\$23.52
LNATDG	LNATDG-P	9 x 3 x 3.5	.020 Aluminum Body with Galv Treadles & Doors	\$22.73	\$21.59	\$24.38	\$23.16
LNAHD	LNAHD-P	9 x 3 x 3.5	0.025 Aluminum	\$25.39	\$24.12	\$27.04	\$25.69
LNG	LNG-P	9 x 3 x 3.5	30 Gauge Galvanized	\$22.46	\$21.34	\$24.11	\$22.91
339A	339A-P	9 x 3 x 3	.020 Aluminum	\$21.48	\$20.41	\$23.13	\$21.98
3310G	3310G-P	10 x 3 x 3	28 Gauge Galvanized	\$22.18	\$21.07	\$23.83	\$22.63
LNG12	LNG12-P	12 x 3 x 3.5	28 Gauge Galvanized	\$27.15	\$25.79	\$28.80	\$27.36
LNG12LB	LNG12LB-P	12 x 3 x 3.5	28 Gauge Galvanized with Long Bridge	\$27.15	\$25.79	\$28.80	\$27.36
3310A	3310A-P	10 x 3 x 3	3310A, 3 x 3 x 10 -- .025 Aluminum	\$24.22	\$23.01	\$25.87	\$24.58
XLKR	XLKR-P	13 x 3 x 3.5	.025 Aluminum Body with Galv. Treadles & Doors	\$31.42	\$29.85	\$33.07	\$31.41
5515AHD	--	15 x 5 x 5	28 Gauge Galvanized	\$44.31	\$42.09	--	--

Folding Sherman Traps

STD Model	Perf Model	L - W - H	Construction	STD	STD 6+	Perf	Perf 6+
SFA	SFA-P	2x 2.5 x 6.5	.020 Aluminum	\$21.84	\$20.74	\$23.49	\$22.31
SFG	SFG-P	6.5 x 2 x 2.5	30 Gauge Galvanized	\$21.36	\$20.29	\$23.01	\$21.86
LFA	LFA-P	3 x 3.5 x 9	.020 Aluminum	\$24.81	\$23.56	\$26.46	\$25.13
LFATDG	LFATDG-P	9 x 3 x 3.5	.020 Aluminum Body, Galv Treadles & Doors	\$25.27	\$24.00	\$26.92	\$25.57
LFAHD	LFAHD-P	9 x 3 x 3.5	.025 Heavy Duty Aluminum	\$26.60	\$25.27	\$28.25	\$26.84
LFG	LFG-P	9 x 3 x 3.5	30 Gauge Galvanized	\$24.29	\$23.07	\$25.94	\$24.64
SFAL	SFAL-P	9 x 2 x 2.5	.020 Aluminum	\$23.45	\$22.28	\$23.93	\$22.73
XLK	XLK-P	12 x 3 x 3.75	.025 Aluminum Body, Galv Treadles & Doors	\$33.95	\$32.25	\$35.60	\$33.82
XLF15	XLF15-P	15 x 4 x 4.5	.025 Aluminum Body with Galv Treadles & Doors	\$44.72	\$42.48	\$46.37	\$44.05

Dura Poly Traps

Plastic traps are made from durable polyethylene and formed into one solid piece. The solid frame construction protects animals from the environment and handlers from animals. It also prevents trapped animals from reaching outside the trap and damaging the surrounding area. And it prevents animals from reaching into the trap and stealing bait.

These traps are an excellent choice when animals need to be trapped in populated areas because captured animals cannot be seen from the outside, and people cannot reach into the trap and disturb the animal.

Model 924 is an excellent choice for skunk because it is completely enclosed.



Model 924

Model	Suggested Target Animal Size	L - W - H	Construction	Wt	Price	6+
924	Cats, Rabbits, Skunks, Opossum	24 x 9 x 9	Polyethylene	7 lbs	\$75.00	\$67.50
1232	Raccoon, Feral Cats, Woodchucks	32 x 12 x 12	Polyethylene	13 lbs	\$85.00	\$76.50

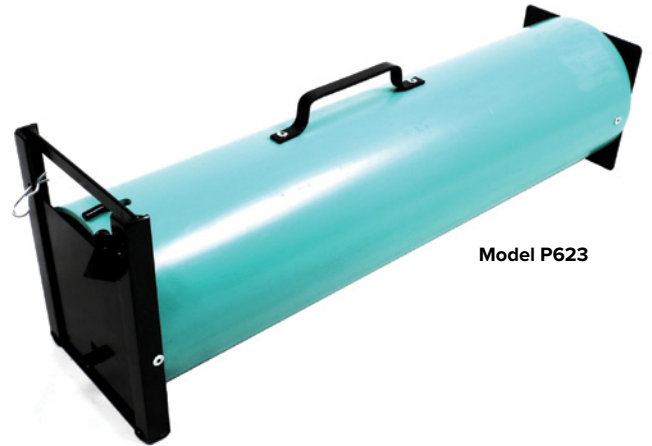

Model P623

Spray Proof Skunk Tube Traps

Tube Traps are excellent for skunk because they are completely enclosed. The trap door is closed with when an animal steps on the inside bait tray. The door shuts by gravity and locks. Available with or without a rear release door.

Model	Description	L - Diameter	Construction	Wt	Price	6+
P623	Spray Proof Skunk Trap	23 x 6	Plastic Composite	9 lbs	\$59.99	\$53.99
P623RD	Spray Proof Skunk Trap with Rear Release Door	23 x 6	Plastic Composite	9 lbs	\$59.99	\$53.99
ADC10	Raccoon Tube Trap	30 x 10	Plastic Composite	29 lbs	\$95.00	\$90.00

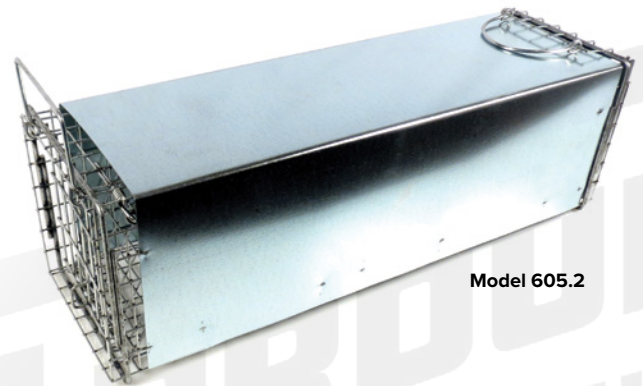

Model 605.2

Tomahawk Sheet Metal Covered Trap

These traps feature a welded on sheet metal cover to protect from direct skunk spray.

Model	Suggested Target Animal Size	L - W - H	Construction	Wt	Price	6+
105.2	Sheet Metal Covered Trap for Skunk	24 x 7 x 7	1 x 1 - 14 gauge	06 lbs	\$70.90	\$64.71
605.2	Sheet Metal Covered Trap for Skunk with Rear Door	24 x 7 x 7	1 x 1 - 14 gauge	06 lbs	\$79.50	\$71.55

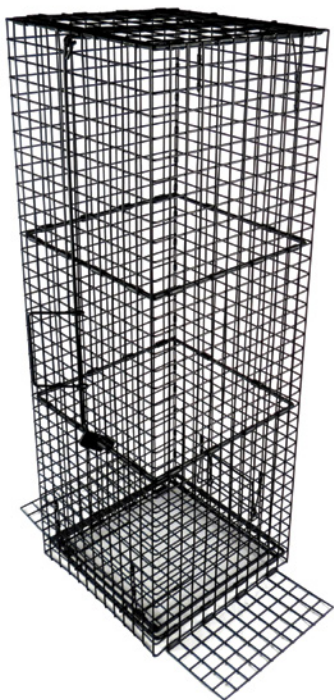

The Tomahawk Chimney Trap

Designed to fit over the chimney flue and is easily secured with two mounting flaps. The trap is triggered when the raccoon exits the chimney, climbs up the trap, and pulls on the rear panel.

Model	L - W - H	Description	Construction	Wt	Price	6+
TCT12	36 x 12 x 12	Chimney Trap for Raccoons	1 x 1 - 12 gauge	15 lbs	\$148.35	\$133.52

Koonce Door Set Raccoon Trap

Model DS100 is a heavy duty trap for raccoons and similar size animals. This unique trap sets by simply lifting the door into the upright position. The recessed door enables you to set the trap flush against trees, buildings and walls. It features a 1/4" steel rod frame wrapped with 14 gauge wire mesh. It also has an easy release rear door and is powder coated black for camouflage.



Model	L-H-W	Description	Construction	Wt	Price	6+
DS100	36 x 12 x 12	Koonce Door Set Raccoon Trap	1 x 1 - 14 gauge	18 lbs	\$89.50	\$80.55

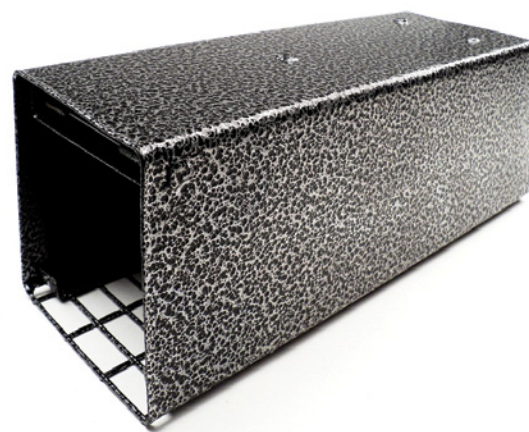

Gopher/Mole Tunnel Trap

Model 2000 is a gopher and mole live trap designed to be partially or completely buried when deployed. This high quality trap is powder coated, super strong and built to last for many years.

Model	Suggested Target Animal Size	L - W - H	Construction	Wt	Price	6+
2000	Gophers, Moles	10 x 3.5 x 3.5	Sheet Metal Trap with Wire Mesh Bottom	1.3 lbs	\$45.00	\$40.50

Bobcat Slammer Traps

Our gravity operated, nest-able bobcat traps are built for easy transportation and quick easy deployment. Features heavy duty, drop down gravity trap doors and large mesh trip plate. They are the strongest bobcat traps available with 1 x 1" - 12 gauge wire mesh frame. All three sizes come with a powder coated black finish. Buy each separately or with greater savings as a nested 3-pack with free shipping.

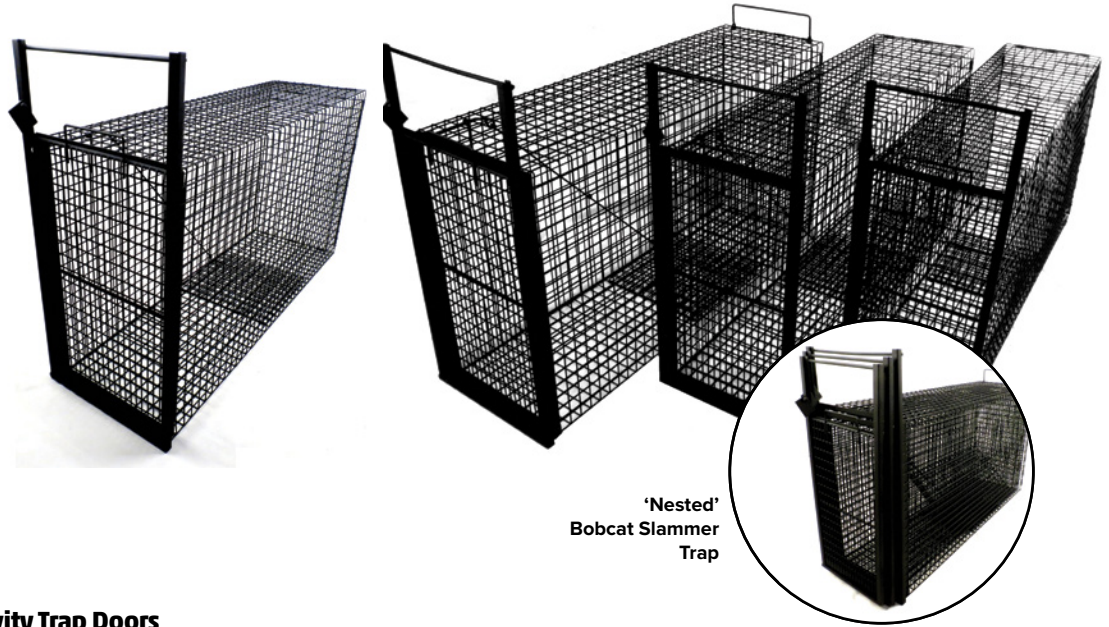

Bobcat Slammer Traps with Gravity Trap Doors

Model	Description	L - W - H	Construction	Wt	Price	6+
BC100	Bobcat Traps with Gravity Trap Doors - Small	36 x 9 x 18	1 x 1 - 12 gauge	15 lbs	\$121.90	\$109.71
BC200	Bobcat Traps with Gravity Trap Doors - Medium	36 x 10 x 19	1 x 1 - 12 gauge	17 lbs	\$127.20	\$114.48
BC300	Bobcat Traps with Gravity Trap Doors - Large	36 x 11 x 20	1 x 1 - 12 gauge	18 lbs	\$132.50	\$119.25
BC3PK	Contains all 3 bobcat traps listed above. - Free Shipping	40 x 24 x 11	1 x 1 - 12 gauge	50 lbs	\$381.60	\$343.44

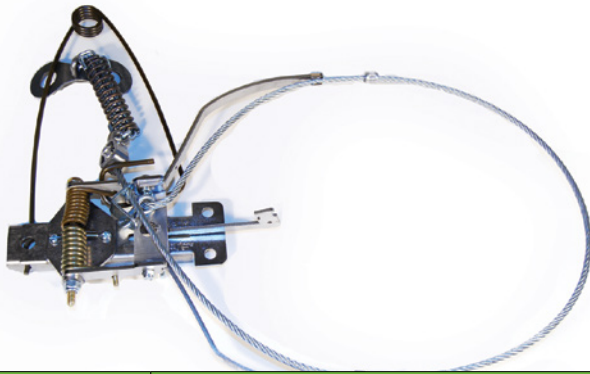

Collarum® Humane Snares

The Collarum® is one of the best and most humane canine capture devices on the market. The Collarum® throws a secure, non-choking cable loop over a canine's head and around the neck making capture faster, easier and more effective than ever before. Triggering requires a "bite & pull" action, which makes the Collarum® canine specific. It won't be set off by other wildlife.

Model	Animal To Use With	Construction	Wt	Price
DM01	Collarum Coyote	Stainless Steel	4 lbs	\$76.95
DM002	Collarum Dog	Stainless Steel	4 lbs	\$96.95
DM003	Collarum Fox	Stainless Steel	4 lbs	\$76.95
DM004	Collarum ACO Special for Dog and Coyote	Stainless Steel	4 lbs	\$135.95
RC3-02C	Coyote - Replacement Cable	Galvanized Aircraft Cable	2 lbs	\$8.95
RC3-03C	Dog - Replacement Cable	Galvanized Aircraft Cable	2 lbs	\$13.95
RC5-01C	Fox - Replacement Cable	Galvanized Aircraft Cable	2 lbs	\$8.95

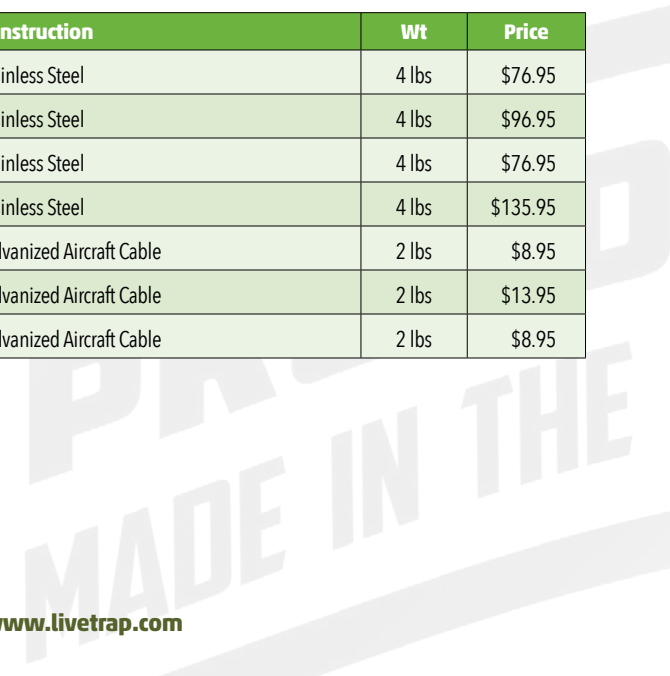

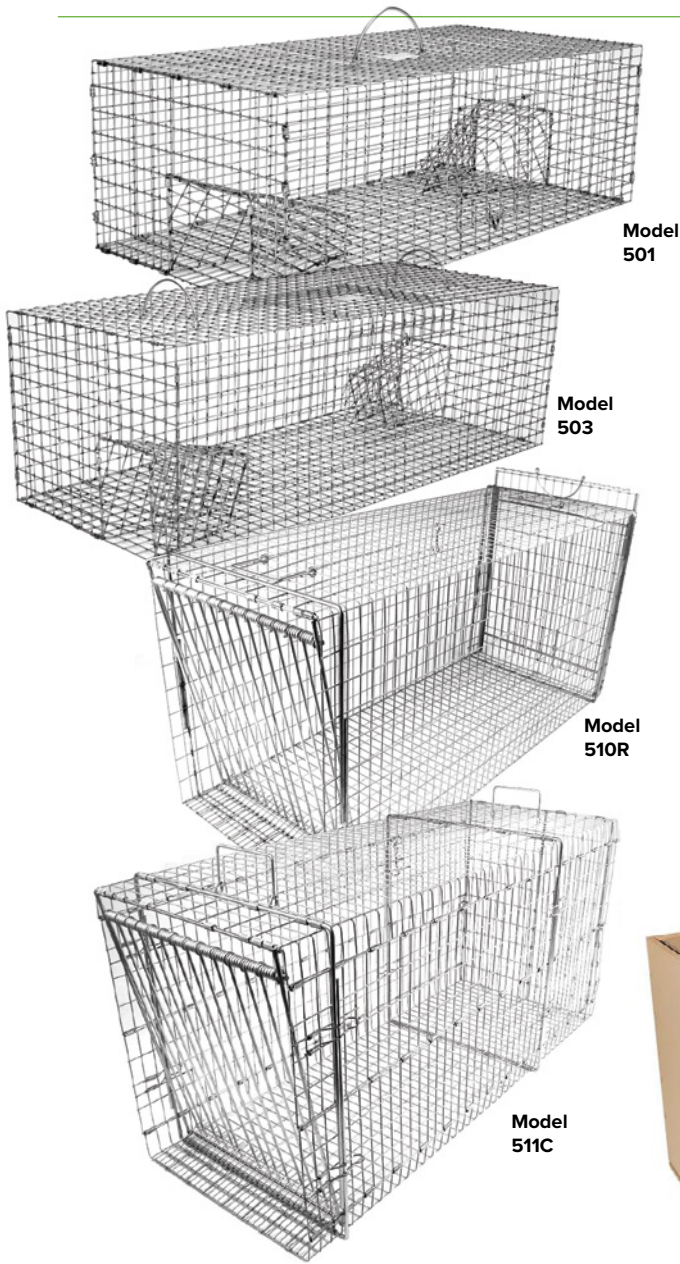

Bird Traps

Our bird traps come assembled with small wire mesh openings, and two repeating trap doors. Birds enter the trap through funnel doors on each end of the trap. The unique design of the funnel doors encourages birds to move forward, into the traps, as they eat the bait.

Model 501, Sparrow Trap comes assembled with a convenient release door which provides easy access to trapped birds. Model 501 is constructed with small wire mesh openings, 1/2" x 1" inch, and two repeating trap doors. Tomahawk's Sparrow Trap can hold up to 20+ sparrow sized birds at one time.

Model 503, Starling Trap comes assembled with a convenient release door which provides easy access to trapped birds. This trap has 1" x 1" wire mesh openings and can hold 15+ starling sized birds at one time.

Model TT-SP15, Indoor Bird Trap is designed specifically to catch birds inside a home or commercial building. When set, the "Trap Door" is simply a welcoming platform with food. Birds stand on the platform eating happily until they press down on the perch. Suddenly, the floor gives way under them and they fall inside the ventilated box with a lid positioned securely above. When a bird is captured it will remain quiet and calm within the holding box until it can be released safely outdoors. Food and water can be left inside to protect the bird. To release the bird outside simply open the "Trap Door" lid and it will fly out.

Model 510R is our rigid chicken trap designed to catch many chickens at a time. Bait your area for several days with trap doors up then lower the trap doors when you are ready to catch chickens.

Model 511C is our collapsible chicken trap designed to catch many chickens at a time. This model collapses to just 4" thick for easy storage.



Model
MODEL TT-SP15



Bird Traps

Model	Description	L - W - H	Construction	Wt	Price	6+
501	Double Door Rigid Sparrow Live Trap	24 x 12 x 8	1/2 x 1 - 16 gauge	4 lbs	\$50.20	\$45.18
503	Double Door Rigid Starling Live Trap	36 x 16 x 12	1 x 1 - 14 gauge	8 lbs	\$50.20	\$45.18

Chicken Traps

Model	Description	L - W - H	Construction	Wt	Price	6+
510R	Rigid Chicken / Rooster Live Trap	42 x 16 x 20	1 x 2 - 14 gauge	18 lbs	\$137.80	\$124.02
511C	Folding Chicken / Rooster Live Trap	42 x 16 x 20	1 x 2 - 14 gauge	18 lbs	\$145.75	\$131.18

Indoor Bird Trap

Model	Description	L - W - H	Construction	Wt	Price	6+
TT-SP15	Sparrow "Trap Door" Plastic Composite	12.5 x 6.5 x 11.5	Plastic Composite	4 lbs	\$124.75	\$112.28
TT-SP20	Sparrow "Trap Door" with Audio	12.5 x 6.5 x 11.5	Plastic Composite	4 lbs	\$173.65	\$156.29

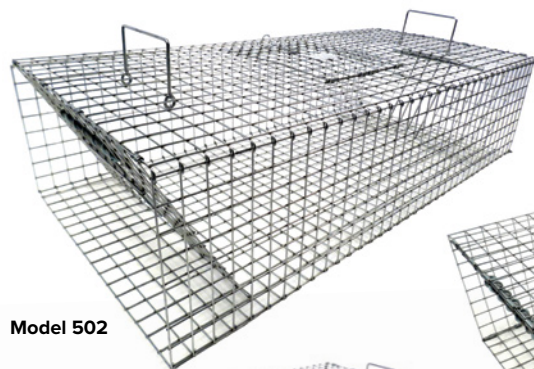

Model 502

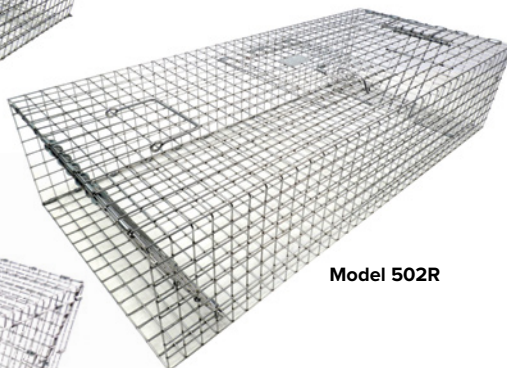

Model 502R

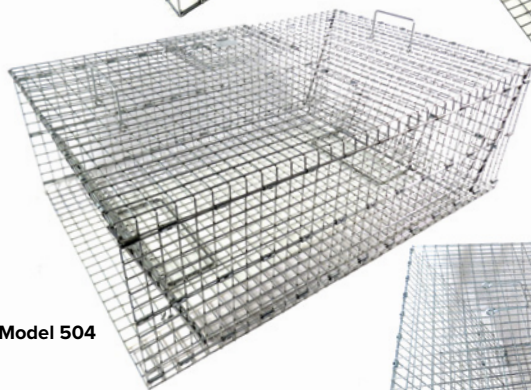

Model 504

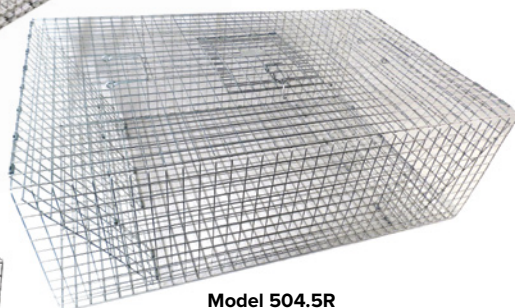

Model 504.5R

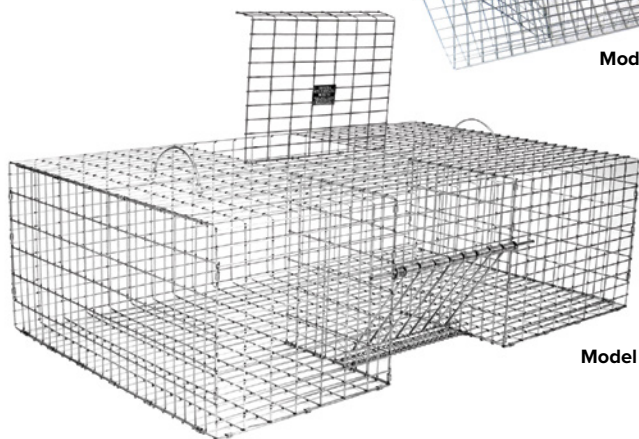

Model 506

502 - Collapsible, double door pigeon trap. Features two, bob style, repeating trap doors and top opening easy release / bait door. This trap is designed to catch and hold 15+ pigeons . It collapses to just one inch in height for easy transportation and sets up in seconds with no tools required.

502R - Rigid, double door pigeon trap. Features two, bob style, repeating trap doors and top opening, easy release / bait door. This pigeon trap is designed to catch and hold 15+ pigeons.

502.5 - Collapsible, two door pigeon trap. Features two, swing panel style, repeating trap doors and top opening, easy release/ bait door. This trap is designed to catch and hold 15+ pigeons. It collapses to just one half inch thick for easy transportation and sets up in seconds with no tools required.

502.5R - Rigid, two door pigeon trap. Features two, swing panel style, repeating trap doors and top opening release / bait door. This trap is designed to catch and hold 15+ pigeons.

504 - Extra-large, collapsible, four door pigeon trap. Features four, bob style, repeating trap doors and top opening, easy release / bait door. This trap is designed to catch and hold 30+ pigeons. It collapses to just three inches tall for easy transportation and storage and sets up in seconds with no tools required.

504R - Extra-large, Rigid, four door pigeon trap. Features four, bob style, repeating trap doors and top opening, easy release / bait door. This trap is designed to catch and hold 30+ pigeons.

504.5 - Extra-large, collapsible, four door pigeon trap. Features four, swing panel style, repeating trap doors and top opening, easy release / bait door. This trap is designed to catch and hold 30+ pigeons. It collapses to just three inches tall for easy transportation and storage and sets up in seconds with no tools required.

504.5R - Extra-large, Rigid, four door pigeon trap. Features four, swing panel style, repeating trap doors and top opening, easy release / bait door. This trap is designed to catch and hold 30+ pigeons.

506 - Extra-large, rigid, single door pigeon trap. Features one, bob style, repeating trap door and top opening, easy release door. This trap is designed to catch and hold 30+ pigeons.

Pigeon Traps

Model	Description	L - W - H	Construction	Wt	Price	6+
502	Folding Pigeon Trap with 2 Bob-Style Doors	35 x 16 x 8	1 x 1 - 14 gauge	7 lbs	\$52.50	\$47.25
502R	Rigid Pigeon Trap with 2 Bob-Style Doors	36 x 16 x 8	1 x 1 - 14 gauge	7 lbs	\$52.50	\$47.25
502.5	Folding Pigeon Trap with 2 Swing Panel Doors	35 x 16 x 8	1 x 1 - 14 gauge	7 lbs	\$52.50	\$47.25
502.5R	Rigid Pigeon Trap with 2 Swing Panel Doors	36 x 16 x 8	1 x 1 - 14 gauge	7 lbs	\$52.50	\$47.25
504	XL Folding Pigeon Trap - 4 Bob-Style Doors	36 x 24 x 10	1 x 1 - 12 gauge	14 lbs	\$94.85	\$85.37
504R	XL Rigid Pigeon Trap - 4 Bob-Style Doors	36 x 24 x 10	1 x 1 - 14 gauge	9 lbs	\$84.25	\$75.83
504.5	XL Folding Pigeon Trap - 4 Swing Panel Doors	36 x 24 x 10	1 x 1 - 12 gauge	14 lbs	\$94.85	\$85.37
504.5R	XL Rigid Pigeon Trap with 4 Swing Panel Doors	36 x 24 x 10	1 x 1 - 14 gauge	9 lbs	\$84.25	\$75.83
506	XL Pigeon Trap with Single Bob Style Door	42 x 24 x 12	1 x 2 - 12 gauge	15 lbs	\$94.85	\$85.37

The Bird Of Prey Trap works by placing bait in the lower section of the trap and setting the perch to hold open the trap doors. When a bird of prey lands on the perch to investigate, the perch gives way under the weight of the bird, causing the trap doors to close above them. When deployed the trap measures 36L x 36W x 42H. This trap ships disassembled for lower ship cost. An instructional assembly video is available on the instructions page of our website and on our YouTube Channel.

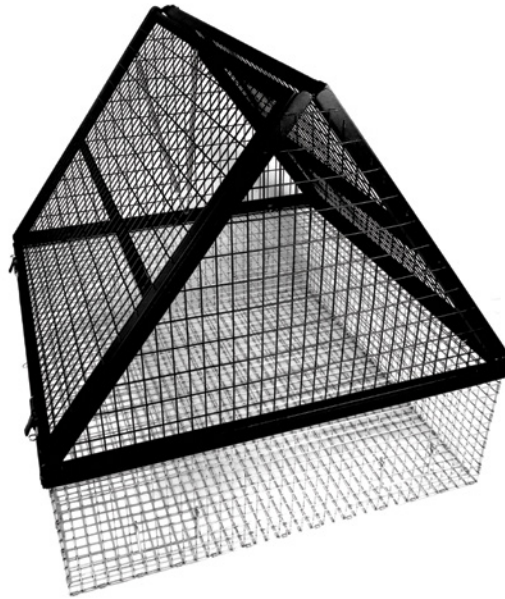

Goshawk / Bird Of Prey Trap

Model	Description	L - W - H	Construction	Wt	Price	6+
520	Hawk Trap	36 x 36 x 12 Base	1 x 2 - 12 GA w/2x2 angle iron frame	85 lbs	\$503.50	\$453.15



The Intimidator Avian Deterrent

A professional quality visual and motion deterrent for woodpeckers and other birds. This high quality deterrent requires very little air current to create a dynamic, colorful, flash and spin effect to deter birds and other wildlife from unwanted areas.

Model	Description	Price	6+
INTD1	Professional Avian Deterrent - Flash & Motion Device	\$29.50	\$26.55



Model 801

Model 801 - Bailey Beaver Trap. This trap is constructed with a heavy duty aluminum frame and chain link mesh. It is triggered when a beaver swims over the trap and bumps the T-bar, causing the spring loaded aluminum jaws to snap into place.

Model KT04

KT04 - KORO Live Beaver Trap. This clam shell style Live Beaver Trap is similar to the Hancock trap. Constructed of a heavy duty aluminum frame and chain link mesh, this trap is built to last a lifetime. It weighs 25 pounds and folds to 6". This trap is designed to capture and hold even the largest beavers.

Model CB39DD

CB39DD - The Comstock Series Beaver Trap is designed for beavers and otters as a swim through trap to be used in water, but can also be used in shallow water or on land. Powerful trap doors help lift and push the animal into the trap. This trap is triggered by a swing bar wire trigger mechanism and comes with a powder coated finish.

Model CB12DD-36

CB12DD-36 - The Comstock 12x12 Beaver Trap is designed for catching beaver or otter in tighter runs where the larger trap may not fit as well. Can be used in water or on land. This trap can also be used for larger raccoon, bobcat and similar sized animals.

Beaver Traps

Model	Description	L - W - H	Construction	Wt	Price	6+
801	Bailey Beaver Trap	39 x 21 x 12	Aluminum Frame and Chain Link Mesh	29 lbs	\$401.70	\$361.53
KT04	Koro / Hancock Beaver Trap	25 x 27 x 6	Aluminum Frame and Chain Link Mesh	25 lbs	\$402.75	\$381.60
CB39DD	Double Door Beaver - 39"	39 x 18 x 12	1½ x 1½ - 12 gauge	23 lbs	\$264.45	--
CB12DD-36	Double Door for Beaver / Raccoon	36 x 12 x 12	1½ x 1½ - 12 gauge	16 lbs	\$158.45	--

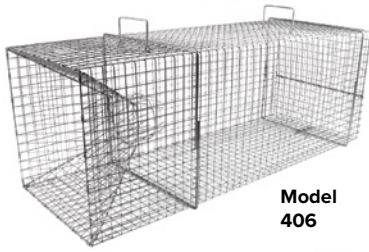

Model 406

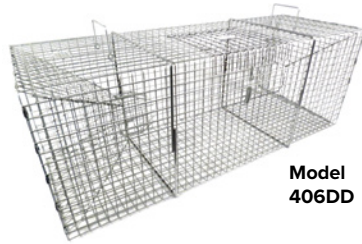

Model 406DD

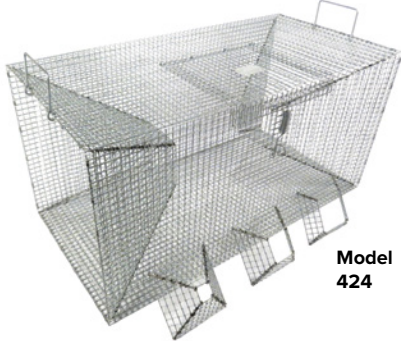

Model 424

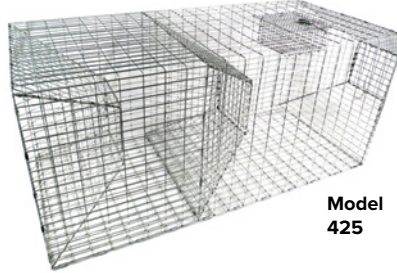

Model 425

Model 406 is an extra-large fish trap with one large funnel trap door entrance and a release door on the opposite end. Funnel entrance is approx. 4" diameter and can be adjusted smaller.

Model 406DD is an extra-large fish trap with two large funnel trap doors and a release door on the top of the trap. Funnel entrance is approx. 4" diameter and can be adjusted smaller.

Model 406W is a pair of extension wings that can easily be added to the front entrance of Model 406. The extensions act as an extremely large funnel system that reaches out 42" on each side of the trap. This greatly increases the number of fish funneled into the trap.

Model 424 is a Perch / Minnow trap with two trap door funnel entrances. This trap comes with three sets of additional funnel sizes that can be used to change the trap door size from 4"x4" down to 3"x3", 2.5"x2.5" or 2" x 2". These cone sizes can be easily attached with zip ties or hog rings.

Model 425 is a Rough Fish / Catfish trap. It features a three cone funnel system, release door and bait compartment.

Fish Traps

Model	Description	L - W - H	Construction	Wt	Price	6+
406	Single Door Rigid XL Fish Trap	42 x 15 x 15	1 x 1 - 14 gauge	12 lbs	\$63.35	\$57.02
406DD	Double Door Rigid XL Fish Trap	42 x 15 x 15	1 x 1 - 14 gauge	13 lbs	\$73.95	\$66.56
406W	Extension Wings for Model 406 & 406DD	42 x 15	1 x 1 - 14 gauge	6 lbs	\$13.35	\$12.02
424	Perch / Minnow Funnel Trap with Changeable Funnel Sizes	30 x 15 x 15	½ x ½ - 16 gauge	12 lbs	\$84.80	\$76.32
425	Funnel Trap for Rough Fish including Catfish	52 x 19 x 19	1 x 2 - 12 gauge	19 lbs	\$132.50	\$119.25

Keep your fish alive and kicking when you are not ready to clean them for the day. Our fish live boxes are a great addition to any dock on the lake or river. Keep the live box in the water when storing fish and simply lift it out to access your days catch. The top opening door features two locks to prevent animals from entering and stealing fish. Made of sturdy 14ga galvanized mesh these live boxes will last for many years.

Model 402.4 & 402.5 - Coated, Rigid Fish Live Boxes - The mesh of these live boxes are made from the same plastic coated wire mesh as lobster pots to prevent corrosion. Features a locking top door to keep out predators such as otter.

Model 402.4C & 402.5C - Coated, Collapsible, Fish Live Boxes - The mesh of these live boxes are made from the same plastic coated wire mesh as lobster pots to prevent corrosion. Features a locking top door to keep out predators such as otter. These live boxes also collapse to just 2" thick for easy storage and transportation.

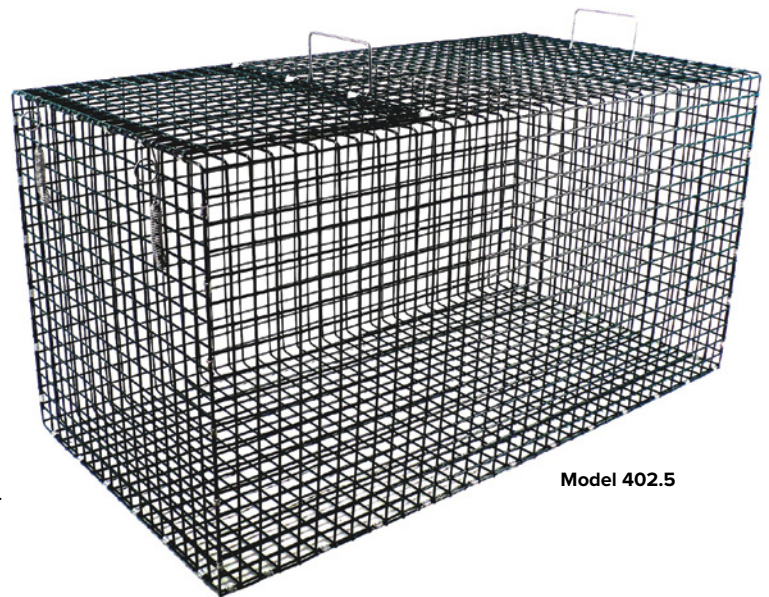

Model 402.5

Fish Live Boxes

Model	Description	L - W - H	Construction	Wt	Price	6+
402.4	Rigid Coated Fish Live Box - Medium	24 x 15 x 15	1 x 1 - 14 gauge	7 lbs	\$63.05	\$56.75
402.5	Rigid Coated Fish Live Box - Large	36 x 18 x 18	1 x 1 - 14 gauge	11 lbs	\$79.50	\$71.55
402.4C	Collapsible Coated Fish Live Box - Medium	24 x 15 x 15	1 x 1 - 14 gauge	7 lbs	\$73.65	\$66.29
402.5C	Collapsible Coated Fish Live Box - Large	36 x 18 x 18	1 x 1 - 14 gauge	11 lbs	\$90.10	\$81.09

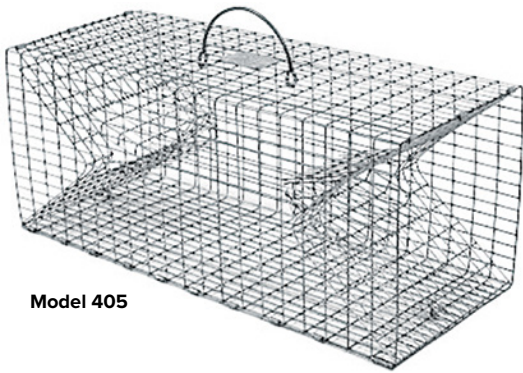

Model 405

Model 405 is a multiple catch crayfish trap with two funnel style doors. This entire trap is made of 1/2" x 1" wire mesh to catch even small and medium sized crayfish. One entire side can be opened as a release door to easily unload your catch.

Model 405.5 is a multiple catch trap for crayfish, crab, and shrimp. This trap is made from 1x1" galvanized wire mesh and features four, 3" wide cone doors that funnel animals into the trap. This trap also features a 4x4" bait box inside the trap made of 1/2" x 1/2" mesh to allow the bait to be seen and smelled but not accessible which allows more animals to enter the trap. One entire side of this trap can be quickly unlatched and opened to allow for easy unloading of your catch.

Model 405.6 is our extra-large crayfish, crab, and shrimp trap featuring three funnel style trap doors. This heavy duty trap is constructed from 1 x 1" - 12 gauge galvanized wire mesh. It includes a 5 x 5" built in bait box constructed from 1/2 x 1/2" galvanized mesh. One entire side of the trap can be quickly unlatched and opened to allow for easy unloading of your catch.



Model 405.5

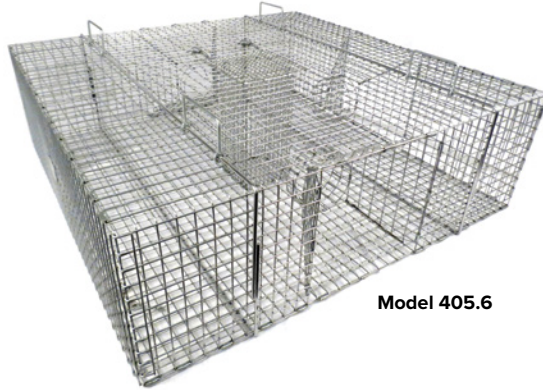

Model 405.6

Crawfish, Crab & Shrimp Traps

Model	Description	L - W - H	Construction	Wt	Price	6+
405	Double Door Crayfish Trap	19 x 8 x 8	1/2 x 1 - 14 gauge	3 lbs	\$26.45	\$23.81
405.5	3 Door Crayfish / Crab / Shrimp Trap	24 x 24 x 9	1 x 1 - 12 gauge	10	\$105.45	\$94.91
405.6	Extra Large 3 Door Crayfish / Crab / Shrimp Trap	36 x 36 x 12	1 x 1 - 12 gauge	25	\$185.50	\$166.95



Our rigid models are effective and inexpensive multiple catch muskrat traps. They are constructed of 14 gauge galvanized wire mesh to protect against corrosion. They have two gravity operated trapdoors.

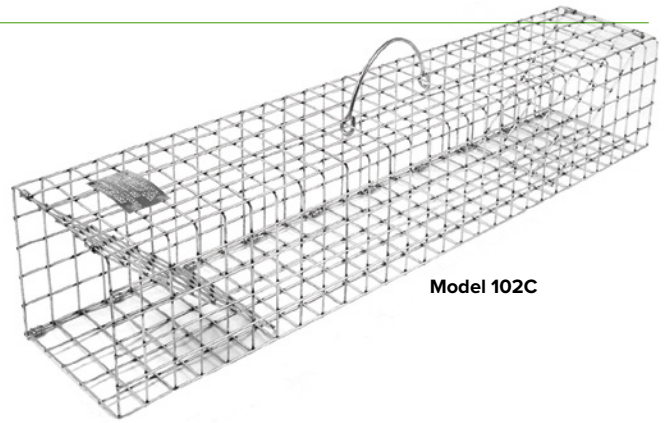

Model 102C

Rigid Colony Muskrat Traps

Model	L - W - H	Construction	Wt	Price	6+
102CS	28 x 5 x 5	1 x 1 - 14 gauge	2 lbs	\$16.95	\$15.26
102CL	36 x 5 x 5	1 x 1 - 14 gauge	3 lbs	\$19.10	\$17.19
103CS	28 x 6 x 6	1 x 1 - 14 gauge	3 lbs	\$21.20	\$19.08
103CL	36 x 6 x 6	1 x 1 - 14 gauge	4 lbs	\$23.30	\$20.97
104CS	28 x 7 x 7	1 x 1 - 14 gauge	4 lbs	\$25.45	\$22.91
104CL	36 x 7 x 7	1 x 1 - 14 gauge	4 lbs	\$27.55	\$24.80
105C	36 x 8 x 8	1 x 1 - 14 gauge	5 lbs	\$29.70	\$26.73
106C	36 x 9 x 9	1 x 1 - 14 gauge	6 lbs	\$33.90	\$30.51
107C	36 x 10 x 10	1 x 1 - 14 gauge	7 lbs	\$38.15	\$34.34

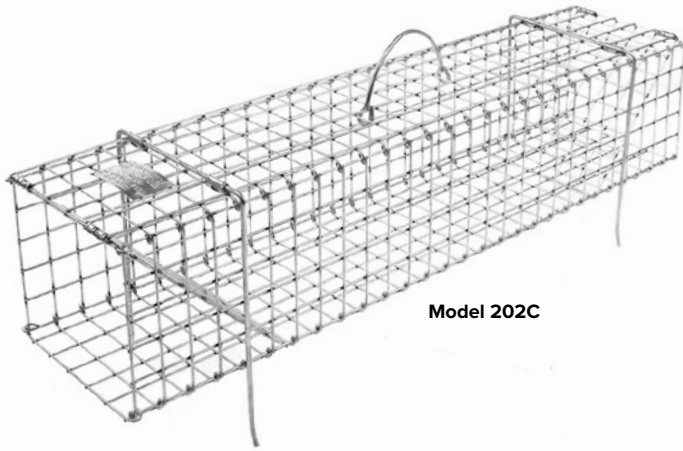

Model 202C

Our collapsible models fold flat in seconds to 1/10th the storage space. They are equipped with two heavy duty U-Bars for added strength and durability. When pushed firmly into the ground, U-Bars hold the trap securely in place preventing muskrats from moving the trap out of position.

Collapsible Colony Muskrat Traps

Model	L - W - H	Construction	Wt	Price	6+
202CS	28 x 5 x 5	1 x 1 - 14 gauge	3 lbs	\$16.95	\$15.26
202CL	36 x 5 x 5	1 x 1 - 14 gauge	3 lbs	\$19.10	\$17.19
203CS	28 x 6 x 6	1 x 1 - 14 gauge	4 lbs	\$25.45	\$22.91
203CL	36 x 6 x 6	1 x 1 - 14 gauge	4 lbs	\$28.10	\$25.29
204CS	28 x 7 x 7	1 x 1 - 14 gauge	5 lbs	\$30.75	\$27.68
204CL	36 x 7 x 7	1 x 1 - 14 gauge	5 lbs	\$33.40	\$30.06
205C	36 x 8 x 8	1 x 1 - 14 gauge	5 lbs	\$36.05	\$32.45
206C	36 x 9 x 9	1 x 1 - 14 gauge	7 lbs	\$41.35	\$37.22
207C	36 x 10 x 10	1 x 1 - 14 gauge	8 lbs	\$46.65	\$41.99

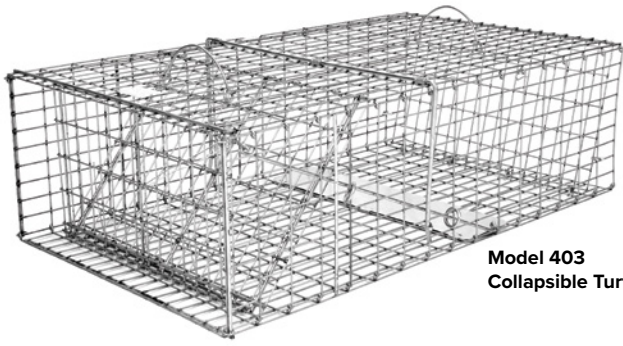

Model 403
Collapsible Turtle Trap

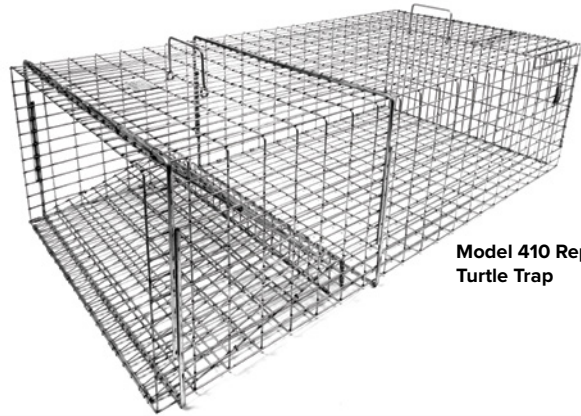

Model 410 Repeating
Turtle Trap

Tomahawk Turtle Traps

Model 403 & 404 are single catch collapsible turtle traps that use a trip pan to trigger the door. Place the trap mostly submerged and bait with raw fish tied inside the rear of the trap behind the trip pan. These traps collapse to just 1" thick for easy storage and transportation and can be deployed in seconds with no tools required.

Model 403R & 404R are single catch rigid traps that use a trip pan to trigger the door. Place the trap mostly submerged and bait with raw fish tied inside the rear of the trap behind the trip pan. These traps collapse to just 1" thick for easy storage and transportation and can be deployed in seconds with no tools required.

Model 409 is a floating turtle trap designed to catch many turtles at a time. When turtles climb up on the black coated aluminum ramps to sun themselves the gravity trap panels tip inward forcing the turtles to slip into the live trap.

Model 410 is a repeating trap for large turtles such as snapping turtles. It can catch and hold 6+ turtles at a time. Place the trap mostly submerged and bait with raw fish inside the trap. Turtles can push in the repeating trap door but cannot push it open from the inside. This trap is also equipped with a bait access door near the rear of the trap.

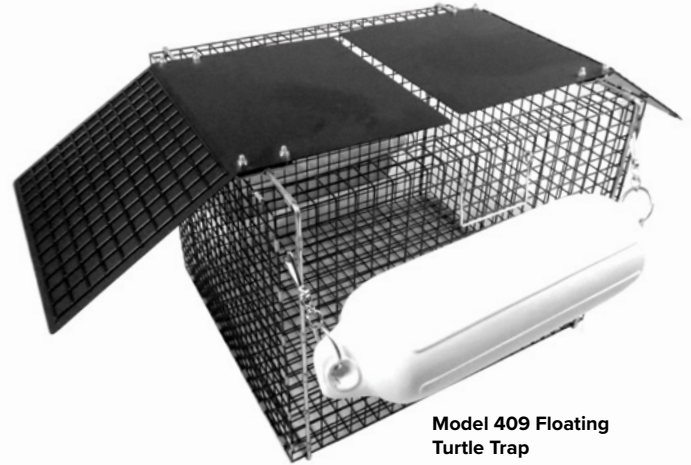

Model 409 Floating
Turtle Trap

Model	Description	L - W - H	Construction	Wt	Price	6+
403	Collapsible Turtle Live Trap for up to 40 lbs	32 x 18 x 9	1 x 2 - 12 gauge	11 lbs	\$105.55	\$95.00
404	Collapsible Turtle Live Trap for up to 100 lbs	40 x 24 x 11	1 x 2 - 12 gauge	19 lbs	\$146.80	\$132.12
403R	Rigid Turtle Live Trap for up to 40 lbs	32 x 18 x 9	1 x 2 - 12 gauge	11 lbs	\$84.80	\$76.32
404R	Rigid Turtle Live Trap for up to 100 lbs	42 x 24 x 11	1 x 2 - 12 gauge	19 lbs	\$114.50	\$103.05
409	Floating, Repeating Turtle Trap for up to 50 lbs	24 x 20 x 18	1 x 1 - 14 gauge	21 lbs	\$169.05	\$152.15
410	Repeating Catch Turtle Trap for Large Turtles	42 x 23 x 12	1 x 2 - 12 gauge	17 lbs	\$103.35	\$93.02

Bullfrog Trap

Our repeating bullfrog trap is designed to hold 20+ frogs at a time. It features two one way entry doors and a top access release door. The two repeating trap doors are made of clear acrylic bobs that allow easy entry. To bait suspend a spinner blade (no hook) with fishing line in the center of the trap as a lure. The flashing of the spinner will attract bullfrogs into the trap.



Model	Description	L - W - H	Construction	Wt	Price	6+
420	Repeating Bullfrog Trap	24 x 24 x 8	1 x 1 - 14 gauge	8 lbs	\$105.95	\$95.35



Snake Trap

Model 460 and 460XL are repeating snake traps that function as a funneling system to catch snakes. The funnel opening of model 460 is a 1.5 inch diameter and the opening of model 460XL is 3 inch diameter. They can both be adjusted tighter if needed for smaller snakes. Both come with a Powder Coated finish to add extra solar heat to the trap enticing snakes to enter. The traps feature wings that can be extended to the sides for funneling snakes into the trap. There is also a removable back door for easy release that features a welded on metal plate for bite protection while removing the rear door lock.

Model	Description	Construction	Size	Wt	Price	6+
460	Repeating Snake Trap	½ x 1 - 16 gauge	24 x 8.5 x 8.5	6 lbs	\$79.50	\$71.55
460XL	Large Repeating Snake Trap	½ x 1 - 14 gauge	36 x 12 x 12	12 lbs	\$111.30	\$100.17

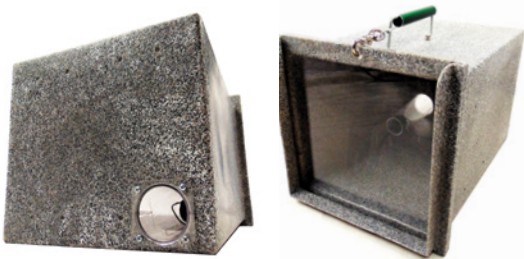

Plastic Repeating Snake Traps

A repeating plastic snake trap designed for catching small and medium size snakes up to 1-1/2" thick. The trap is made from durable polyethylene and will hold up to the elements for many years. Trap is baited with scent lure and heat packs or caged mouse inside the trap. Snakes can pass through the cone with a repeating door but cannot push back out. The trap features a clear or tinted plastic door for easy viewing and removal of trapped snakes.

Model	Description	L-W-H	Wt	Price	6+
465W	Dura-Poly Plastic Repeating Snake Trap - White with Clear or Tinted Door	17 x 12 x 12	6.3 lbs	\$79.95	\$71.96
465G	Dura-Poly Plastic Repeating Snake Trap - Grey with Clear or Tinted Door	17 x 12 x 12	6.3 lbs	\$79.95	\$71.96
465T	Dura-Poly Plastic Repeating Snake Trap - Tan with Clear or Tinted Door	17 x 12 x 12	6.3 lbs	\$79.95	\$71.96

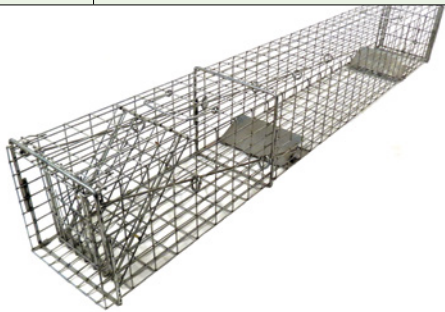

Double Pan Snake Trap

The double pan snake/reptile trap is a cage trap with a 2 pan system designed to catch large snakes or reptiles only. Snakes and reptiles have long bodies that are either dragged along the ground or very low to the ground. This enables them to press both pans at the same time and trigger the trap. Other animals such as mammals will walk over one pan at a time and not trigger the trap. This trap also features a removable rear door for easy animal release welded on metal plate for bite protection while removing the rear door lock.

Model	Description	Construction	L-W-H	Wt	Price	6+
461	Double Pan Snake Trap for Small Snakes	½ x 1 - 14 gauge	36L x 6W x 6H	5lbs	\$84.25	\$75.83
462	Double Pan Snake Trap for Medium Snakes	1 x 1 - 14 gauge	42L x 7W x 7H	7lbs	\$94.85	\$85.37
463	Double Pan Snake Trap for Large Snakes	1 x 1 - 12 gauge	60L x 8W x 8H	11lbs	\$111.30	\$100.17

Reptile / Lizard Trap

Model 450 is a repeating lizard trap designed to catch and hold multiple reptiles at a time. The doors are made of 6 gauge metal bobs that swing freely inward to let animals enter but cannot be pushed open from the inside. This trap also features an easy bait and release door on the top of the trap.



Model	Description	Construction	Size	Wt	Price	6+
450	Repeating Reptile Trap	1 x 1 - 12 gauge	32 x 18 x 9	14 lbs	\$94.35	\$84.92



All Of Our Standard Tongs Feature:

- Stainless steel aircraft quality cable
- Concealed stainless steel jaw springs
- Very strong cast aluminum handles, levers, and tong jaws
- Pistol grip handle designed for one hand operation
- Anodized tube shafts to withstand the elements
- Super Tube Tongs have all of the above and feature a .090 thick wall tube

Standard Tongs

Economical, safe and effective. Our standard tongs are light weight and very durable tools that act as an extension of your arm to grab just about anything. The pistol style handle allows for a precise feel of pressure being applied. The super tube option allows you to choose a heavy duty, double thick aluminum tube for even greater durability.

Standard Model	Super Tube Model	Description	Wt	Standard Price	Standard 6+	Super Tube Price	Super Tube 6+
312	312S	24" Standard Tong	1.1 lbs	\$59.95	\$53.96	\$69.95	\$62.96
313	313S	30" Standard Tong	1.1 lbs	\$59.95	\$53.96	\$69.95	\$62.96
314	314S	36" Standard Tong	1.2 lbs	\$59.95	\$53.96	\$69.95	\$62.96
315	315S	42" Standard Tong	1.2 lbs	\$59.95	\$53.96	\$69.95	\$62.96
316	316S	48" Standard Tong	1.3 lbs	\$69.95	\$62.96	\$79.95	\$71.96
317	317S	60" Standard Tong	1.4 lbs	\$79.95	\$71.96	\$89.95	\$80.96
318	318S	72" Standard Tong	1.5 lbs	\$89.95	\$80.96	\$99.95	\$89.96
TRC		Pair of Standard Tong Cushions	.5 lbs	\$3.25	\$2.93		

Standard Collapsible Tongs with Super Tube - Cast Aluminum

Collapsible tongs are ideal for saving space. They fold to half of the deployed length when not in use and simply snap together when needed for quick deployment. These collapsible tongs have a .090 thick walled super tube.

Model	Description	Wt	Price	6+
315C	42" Super Tube - Collapses to 21"	2 lbs	\$84.95	\$76.46
316C	48" Super Tube - Collapses to 24"	2.1 lbs	\$94.95	\$85.46
317C	60" Super Tube - Collapses to 30"	2.2 lbs	\$104.95	\$94.46
318C	72" Super Tube - Collapses to 36"	2.4 lbs	\$114.95	\$103.46

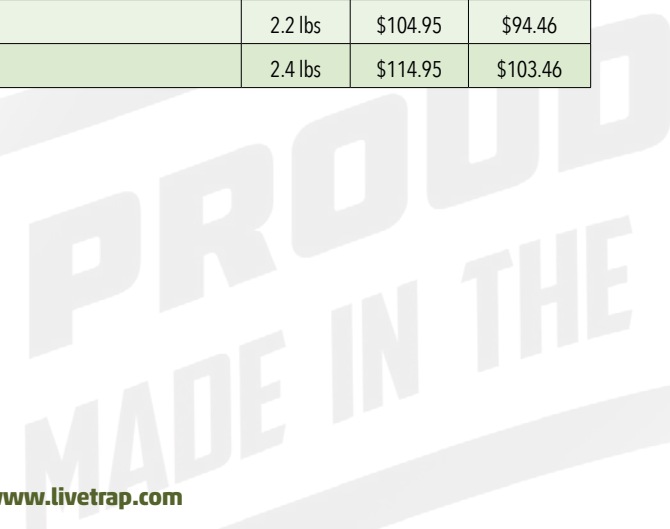



All Of Our Deluxe Tongs Feature:

- Stainless steel aircraft quality cable
- Concealed stainless steel jaw springs
- Very strong cast aluminum handles, levers, and tong jaws
- Pistol grip handle designed for one hand operation
- Anodized tube shafts to withstand the elements
- 2-1/2" wide cast aluminum jaws
- Super Tube Tongs have all of the above and feature a .090 thick wall tube

Deluxe Tongs

Deluxe Tongs - Deluxe tongs are built to handle any job from small to large snakes. They feature 2-1/2" wide cast aluminum jaws that distribute holding pressure over a larger area. The super tube option allows you to choose a heavy duty, double thick aluminum tube for even greater durability.

Standard Model	Super Tube Model	Description	Wt	Standard Price	Standard 6+	Super Tube Price	Super Tube 6+
412	412S	24" Deluxe Snake Tong	1.5 lbs	\$69.95	\$62.96	\$79.95	\$71.96
413	413S	30" Deluxe Snake Tong	1.6 lbs	\$69.95	\$62.96	\$79.95	\$71.96
414	414S	36" Deluxe Snake Tong	1.8 lbs	\$69.95	\$62.96	\$79.95	\$71.96
415	415S	42" Deluxe Snake Tong	1.9 lbs	\$69.95	\$62.96	\$79.95	\$71.96
416	416S	48" Deluxe Snake Tong	2.0 lbs	\$79.95	\$71.96	\$89.95	\$80.96
417	417S	60" Deluxe Snake Tong	2.3 lbs	\$89.95	\$80.96	\$99.95	\$89.96
418	418S	72" Deluxe Snake Tong	2.5 lbs	\$99.95	\$89.96	\$109.95	\$98.96
LRC		Deluxe Snake Tong Cushions	.5 lbs	\$4.35	\$3.92		

Deluxe Collapsible Super Tube Tongs - Cast Aluminum

Collapsible tongs are ideal for saving space. They fold to half of the deployed length when not in use and simply snap together when needed for quick deployment. These tongs have a .090 thick wall super tube.

Model	Description	Wt	Price	6+
415C	42" Deluxe Tong - Collapses to 21"	2.1 lbs	\$94.95	\$85.46
416C	48" Deluxe Tong - Collapses to 24"	2.2 lbs	\$104.95	\$94.46
417C	60" Deluxe Tong - Collapses to 30"	2.5 lbs	\$114.95	\$103.46
418C	72" Deluxe Tong - Collapses to 36"	2.8 lbs	\$124.95	\$112.46

CUSTOM LENGTHS AVAILABLE FOR ALL STYLES UPON REQUEST – CALL OR EMAIL FOR QUOTE



All of Our Extreme Grip Tongs Feature:

- Stainless steel aircraft quality cable
- Tightest grip of all of our tongs
- Pistol grip handle designed for one hand operation
- Anodized tube shafts to withstand the elements
- Super Tube Tongs have all of the above and feature a .090 thick wall tube

Extreme Grip Tongs - Cast Aluminum

These tongs have the same great features as our standard cast aluminum tongs, except they have a different style gripping jaw preferred by some handlers. These tongs also have an exposed spring and partially exposed cable. See photo. Super tube tongs have a .090 thick wall tube.

Standard Model	Super Tube Model	Description	Wt	Standard Price	Standard 6+	Super Tube Price	Super Tube 6+
312AE	312AES	24" Aluminum Extreme Grip Snake Tong	1.1 lbs	\$59.95	\$53.96	\$69.95	\$62.96
313AE	313AES	30" Aluminum Extreme Grip Snake Tong	1.1 lbs	\$59.95	\$53.96	\$69.95	\$62.96
314AE	314AES	36" Aluminum Extreme Grip Snake Tong	1.2 lbs	\$59.95	\$53.96	\$69.95	\$62.96
315AE	315AES	42" Aluminum Extreme Grip Snake Tong	1.2 lbs	\$59.95	\$53.96	\$69.95	\$62.96
316AE	316AES	48" Aluminum Extreme Grip Snake Tong	1.3 lbs	\$69.95	\$62.96	\$79.95	\$71.96
317AE	317AES	60" Aluminum Extreme Grip Snake Tong	1.4 lbs	\$79.95	\$71.96	\$89.95	\$80.96
318AE	318AES	72" Aluminum Extreme Grip Snake Tong	1.5 lbs	\$89.95	\$80.96	\$99.95	\$89.96

Extreme Grip Tongs - Nylon

These light weight tongs are perfect for handling small to medium size reptiles. Tong jaws and pistol grip handle are made of super strong nylon. The tube is anodized aluminum with a .045 wall thickness.

Model	Description	Wt	Price	6+
312NE	24" Nylon Extreme Grip Tong	.7 lbs	\$54.95	\$49.46
313NE	30" Nylon Extreme Grip Tong	.7 lbs	\$54.95	\$49.46
314NE	36" Nylon Extreme Grip Tong	.8 lbs	\$54.95	\$49.46
315NE	42" Nylon Extreme Grip Tong	.8 lbs	\$54.95	\$49.46
316NE	48" Nylon Extreme Grip Tong	.9 lbs	\$64.95	\$58.46
317NE	60" Nylon Extreme Grip Tong	.9 lbs	\$74.95	\$67.46
318NE	72" Nylon Extreme Grip Tong	1 lb	\$84.95	\$76.46

CUSTOM LENGTHS AVAILABLE FOR ALL STYLES UPON REQUEST – CALL OR EMAIL FOR QUOTE





Ton Jones Standard Snake Tongs

Ton Jones Snake Tongs feature a 22 degree bend in the tube to keep the jaw head flat with the ground while grabbing snakes and reptiles. Standard tongs with super tube feature a double thick aluminum tubes with .090 wall thickness for added durability.

Standard Model	Super Tube Model	Description	Wt	Standard Price	Standard 6+	Super Tube Price	Super Tube 6+
TJ313	TJ313S	30" Ton Jones Standard Tong	1.5 lb	\$69.95	\$62.96	\$79.95	\$71.96
TJ314	TJ314S	36" Ton Jones Standard Tong	1.5 lb	\$69.95	\$62.96	\$79.95	\$71.96
TJ315	TJ315S	42" Ton Jones Standard Tong	1.5 lb	\$69.95	\$62.96	\$79.95	\$71.96
TJ316	TJ316S	48" Ton Jones Standard Tong	2 lbs	\$79.95	\$71.96	\$89.95	\$80.96
TJ317	TJ317S	60" Ton Jones Standard Tong	2.5 lbs	\$89.95	\$80.96	\$99.95	\$89.96
TJ318	TJ318S	72" Ton Jones Standard Tong	3 lbs	\$99.95	\$89.96	\$109.95	\$98.96



Ton Jones Deluxe Snake Tongs

Ton Jones Snake Tongs feature a 22 degree bend in the tube to keep the jaw head flat with the ground while grabbing snakes and reptiles. Deluxe snake tongs feature wide 2.5" cast aluminum jaws. The wider jaw distributes holding pressure over a larger area to prevent trauma to the animal and provides more holding power to the handler. Deluxe tongs with super tube feature a double thick aluminum tubes with .090 wall thickness for added durability.

Deluxe Model	Super Tube Model	Description	Wt	Standard Price	Standard 6+	Super Tube Price	Super Tube 6+
TJ413	TJ413S	30" Ton Jones Deluxe Snake Tong	1.5 lb	\$79.95	\$71.96	\$89.95	\$80.96
TJ414	TJ414S	36" Ton Jones Deluxe Snake Tong	1.5 lb	\$79.95	\$71.96	\$89.95	\$80.96
TJ415	TJ415S	42" Ton Jones Deluxe Snake Tong	2 lbs	\$79.95	\$71.96	\$89.95	\$80.96
TJ416	TJ416S	48" Ton Jones Deluxe Snake Tong	2 lbs	\$89.95	\$80.96	\$99.95	\$89.96
TJ417	TJ417S	60" Ton Jones Deluxe Snake Tong	3 lbs	\$99.95	\$89.96	\$109.95	\$98.96
TJ418	TJ418S	72" Ton Jones Deluxe Snake Tong	3.5 lbs	\$109.95	\$98.96	\$119.95	\$107.96

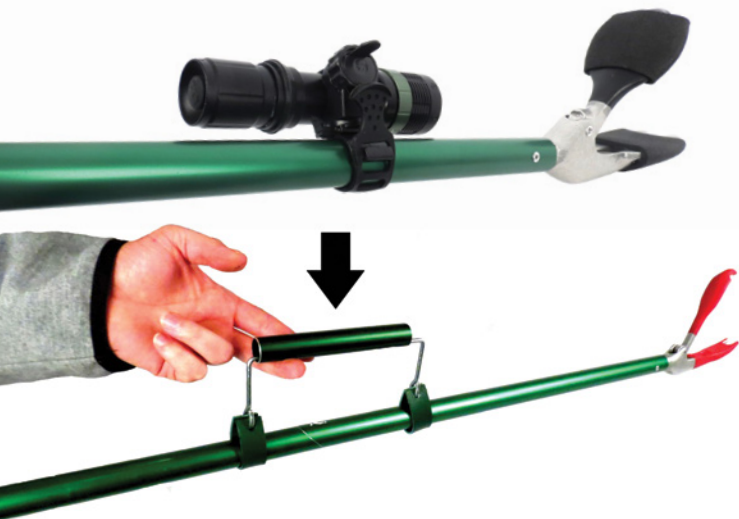

Model FL100-C is our flashlight & attachment combo designed to work with all snake tongs, animal graspers & animal control poles. This flashlight kit attaches directly to the pole allowing you to see in dark crawlspaces and crevices while searching for snakes or animals. The powerful LED flashlight can also be detached from the holding unit quickly if needed. Flashlight and attachment can also be purchased separately.

Model STH is a support handle that can be strapped to the tube of the tong for extra support when lifting heavy snakes.

TRC & LRC are cushions that can be put on our snake tongs for extra animal protection and comfort. Model TRC is a pair of cushions for standard tongs only and model LRC is a pair of cushions for deluxe tongs only.

Snake Tong Accessories

Model	Description	Wt	Price	6+
FL100-F	LED Flashlight for Snake Tong / Animal Grasper	6 oz	\$14.95	\$13.46
FL100-H	Flashlight Holder Attachment for Tong or Grasper	3 oz	\$4.95	\$4.46
FL100-C	LED Flashlight and Flashlight Holder Combo	9 oz	\$17.50	\$15.75
STH	Snake Tong Support Handle	.6 lbs	\$9.95	\$8.96
TRC	Standard Tong Cushions - Pair	.5 lbs	\$3.25	\$2.93
LRC	Deluxe Tong Cushions - Pair	.5 lbs	\$4.35	\$3.92



Reptile Containment Buckets

Made in the USA from food grade plastic resin for the safe transportation of reptiles. These buckets are heavy duty at .90 millimeters thick and include a two part lid with an outer ring that snaps into the bucket and an inner removable lid that simply spins onto the outer ring and locks into place. The inner lid has 36 drilled 1/8" air holes with each air hole protected by 1" lid reinforcement wedges making it impossible for snakes to get fangs through the air holes. This bucket has an 11" wide diameter and is 10" deep. Available in 3 or 5 gallon sizes with or without lids. Extra lids can also be purchased separately.

Model	Description	Size	Wt	Price	6+
RCB003	Reptile Containment Bucket - 3 Gallon	3 Gallon	1 lbs	\$12.00	\$11.40
RCBL003	Reptile Containment Bucket - 3 Gallon with Lid	3 Gallon	2 lbs	\$22.00	\$20.90
RCB005	Reptile Containment Bucket - 5 Gallon	5 Gallon	3 lbs	\$12.00	\$11.40
RCBL005	Reptile Containment Bucket - 5 Gallon with Lid	5 Gallon	4 lbs	\$22.00	\$20.90
RCBL	Lid for Reptile Containment Buckets	1 lbs	\$12.00	\$11.40	

Snake Bagging Systems

Model	Description	Wt	Price	6+
SHB-H	Bag-a-Snake Complete Snake Bagging System with Bag, Triangular Hoop, Shaft	2.25 lbs	\$73.45	\$67.05
SHB-HN	Replacement Net for SHB-H	.5 lbs	\$26.10	\$67.05





Standard Snake Hooks

Our Standard Snake Hooks are 46" long with a golf club grip at one end and a hook formed from 9/32" stainless steel rod at the other end. The hook has a 3 1/2" opening. The shaft is a lightweight but very strong golf club steel shaft. These are Heavy Duty Snake Hooks built to last for many years.

Model	Description	Construction	Wt	Price	6+
319	46" Standard Snake Hook	Steel Shaft, Stainless Steel Hook	1 lb	\$29.00	\$26.10
319A	46" Standard Snake Hook	Steel Shaft, Anodized Aluminum Hook	1 lb	\$29.00	\$26.10
320	39" to 17" Collapsible Snake Hook	Aluminum Shaft, Stainless Steel Hook	1 lb	\$46.00	\$41.40
321-24	24" Cage Hook	Stainless Steel Shaft and Hook	1 lb	\$24.95	\$22.46

Flat Snake Hook



Flat Bar Snake Hooks

These snake hooks feature a flat bar style hook that allows for more surface area contact giving the handler more control of the snake. Available in standard size for average snakes and XL sizes for very large snakes such as Boa Constrictors.

Model	Description	Construction	Wt	Price	6+
322	46" Flat Snake Hook	Stainless Steel Shaft, 1/2" Flat Bar Steel Hook	2 lbs	\$29.00	\$26.10
325S	44" XL Super Snake Hook	Aluminum Shaft, 1" Flat Bar Steel Hook	2.2 lbs	\$60.00	\$54.00
325L	54" XL Super Snake Hook	Aluminum Shaft, 1" Flat Bar Steel Hook	2.5 lbs	\$60.00	\$54.00

33DH2 330DH 330FH 330PH 330SH



Hydra Hook with Interchangeable Heads

These snake hooks feature a flat bar style hook that allows for more surface area contact giving the handler more control of the snake. Available in standard size for average snakes and XL sizes for very large snakes such as Boa Constrictors.

Model	Description	Wt	Price	6+
330	40" Rigid Complete Hydra Hook Set with 6 heads	6 lbs	\$149.50	\$134.55
330HK	40" Rigid Hydra Hook Half Set with Choice of 3 Heads	4 lbs	\$89.95	\$80.96
330C	Collapsible Complete Hydra Hook Set with 6 Heads	6 lbs	\$159.50	\$143.55
330CHK	Collapsible Hydra Hook Half Set with Choice of 3 Heads	4 lbs	\$99.95	\$89.96
330P	40" Rigid Hydra Pole	1.5 lbs	\$25.00	\$22.50
330CP	40" Collapsible to 20" Hydra Pole	1.5 lbs	\$35.00	\$31.50
330FH	Flat Hydra Hook Head	.5 lbs	\$24.95	\$22.46
330SH	Standard Hydra Hook Head	.5 lbs	\$24.95	\$22.46
330PH	Pinning Hydra Hook Head	.5 lbs	\$24.95	\$22.46
330DH	1" Hydra Double Hook Head	.5 lbs	\$24.95	\$22.46
330DH2	2" Hydra Double Hook Head	.5 lbs	\$24.95	\$22.46
330DH3	3" Hydra Double Hook Head	.5 lbs	\$24.95	\$22.46



Ton Jones Stump Rippers

are designed for pulling debris out of the way from a distance. It is made from .090 thick tempered aluminum tube and features a neoprene handle for comfortable, non-slip grip even in wet conditions. The hook end of the ripper is made of 3/8" Stainless Steel and will hold up against large rocks, logs, and anything else you want to throw at it.

Ton Jones Snake Pinners

are available in 2" and 3" wide pinning heads. The pinning head is made of surgical tubing to safely pin the snake.

Ton Jones Snake Hooks

are constructed from aluminum tube and feature comfortable, non-slip neoprene grip. The hook end is made from 9/32" stainless steel and has a 3 1/2" opening.

Ton Jones Stump Rippers

Model	Description	Wt	Price	6+
SR20	20" Ton Jones Stump Ripper	1lb	\$50.00	\$45.00
SR30	30" Ton Jones Stump Ripper	1.25 lb	\$55.00	\$49.50
SR40	40" Ton Jones Stump Ripper	1.5 lb	\$60.00	\$54.00
SR50	50" Ton Jones Stump Ripper	1.5 lb	\$65.00	\$58.50
SR60	60" Ton Jones Stump Ripper	1.5 lb	\$70.00	\$63.00

Ton Jones Snake Pinners

Model	Description	Wt	Price	6+
TJPH30-2	2" Ton Jones Pinning Head with 30" Pole	1.5 lbs	\$45 00	\$40.50
TJPH30-3	3" Ton Jones Pinning Head with 30" Pole	1.5 lbs	\$45 00	\$40.50
TJPH40-2	2" Ton Jones Pinning Head with 40" Pole	2 lbs	\$50 00	\$45 00
TJPH40-3	3" Ton Jones Pinning Head with 40" Pole	2 lbs	\$50 00	\$45 00

Ton Jones Snake Hooks

Model	Description	Wt	Price	6+
TJSH24	24" Ton Jones Standard Snake Hook	0.75 lb	\$35.00	\$31.50
TJSH28	28" Ton Jones Standard Snake Hook	0.62 lb	\$36.25	\$32.63
TJSH34	34" Ton Jones Standard Snake Hook	0.75 lb	\$37.50	\$33.75
TJSH38	38" Ton Jones Standard Snake Hook	1 lb	\$38.75	\$34.88
TJSH44	44" Ton Jones Standard Snake Hook	1.25 lbs	\$40 00	\$36 00
TJSH48	48" Ton Jones Standard Snake Hook	1.5 lbs	\$41.25	\$37.13
TJSH24HD	24" Ton Jones Heavy Duty Snake Hook	1 lb	\$40 00	\$36 00
TJSH28HD	28" Ton Jones Heavy Duty Snake Hook	1.25 lbs	\$41.25	\$37.13
TJSH34HD	34" Ton Jones Heavy Duty Snake Hook	1.5 lbs	\$42.50	\$38.25
TJSH38HD	38" Ton Jones Heavy Duty Snake Hook	1.75 lbs	\$43.75	\$39.38
TJSH44HD	44" Ton Jones Heavy Duty Snake Hook	2 lbs	\$45 00	\$40.50
TJSH48HD	48" Ton Jones Heavy Duty Snake Hook	2.25 lbs	\$46.25	\$41.63



Solid nylon hoops. Provides strength and flexibility. These nets can be pressed firmly against the ground or wall to entrap animals even when the net shaft is at an angle. This allows handlers to stand upright while netting and restraining animals.

Long neoprene grips. Allows handlers to securely grab net shafts without slips, even when wet.

Heavy aluminum handles. The 1" aluminum tube handle provides added strength and durability.

Woven 3/4" nylon mesh netting. Does not propagate tears, unravel, or weaken from adjacent tears. Net seams are surged with polyester thread, and small mesh size prevents animal entanglements.

1/8" WOVEN NYLON HEM. Most wear and tear suffered by animal nets is to the hem that attaches the net to the hoop. This design will easily handle abrasive surfaces like concrete.

Tie-off cords. Allows handlers to secure animals in the bottom of the net.

Mini Dura-Flex Animal Net

Mini Dura-Flex Animal Nets have a 48" hoop circumference and are 44" Deep. They feature a tie off cord, comfort grip handle and flexible nylon hoop. This is an excellent net for cats and smaller sized animals.

Model	Description	Construction	Wt	Price	6+
LH100	Small Dura-Flex Replacement Net	Nylon Net - 4' Circumference, 44" Deep	2 lbs	\$49.50	\$44.55
LH101	Small Dura-Flex Net w/ 2' Shaft	Aluminum Tube, Nylon Net	3 lbs	\$82.50	\$74.25
LH102	Small Dura-Flex Net w/ 3' Shaft	Aluminum Tube, Nylon Net	4 lbs	\$85.50	\$76.95
LH103	Small Dura-Flex Net w/ 4' Shaft	Aluminum Tube, Nylon Net	5 lbs	\$88.50	\$79.65

Standard Dura-Flex Animal Net

Standard Dura-Flex Animal Nets have a 72" hoop circumference and are 50" Deep. They feature a tie off cord, comfort grip handle and flexible nylon hoop. This is an excellent net for cats, small dogs and similar sized animals.

Model	Description	Construction	Wt	Price	6+
SN200	Standard Dura-Flex Replacement Net	Nylon Net - 6' Circumference, 50" Deep	3 lbs	\$49.50	\$44.55
SN201	Standard Dura-Flex Net w/3' Handle	Aluminum Handle, Nylon Net, Nylon Hoop	4 lbs	\$92.50	\$83.25
SN202	Standard Dura-Flex Net w/4' Handle	Aluminum Handle, Nylon Net, Nylon Hoop	5 lbs	\$95.50	\$85.95
SN203	Standard Dura-Flex Net w/5' Handle	Aluminum Handle, Nylon Net, Nylon Hoop	6 lbs	\$98.50	\$88.65

Heavy Duty Dura-Flex Animal Net

Heavy Duty Dura-Flex Animal Nets have a 96" hoop circumference and are 56" Deep. They feature a tie off cord, comfort grip handle and flexible nylon hoop. This is an excellent net for cats, dogs and similar sized animals.

Model	Description	Construction	Wt	Price	6+
HN300	Heavy Duty Dura-Flex Replacement Net	Nylon Net - 8' Circumference, 56" Deep	4 lbs	\$49.50	\$44.55
HN301	Heavy Duty Dura-Flex Net w/3' Handle	Aluminum Handle, Nylon Net, Nylon Hoop	5 lbs	\$102.50	\$92.25
HN302	Heavy Duty Dura-Flex Net w/4' Handle	Aluminum Handle, Nylon Net, Nylon Hoop	6 lbs	\$105.50	\$94.95
HN303	Heavy Duty Dura-Flex Net w/5' Handle	Aluminum Handle, Nylon Net, Nylon Hoop	7 lbs	\$108.50	\$97.65

Y-Poles

Y-poles are excellent tools for creating space between yourself and an aggressive animal and for pinning animals to the ground or against walls when needed. They feature soft neoprene padded cushions to prevent animal injury and neoprene handle for a comfortable grip.

Model	Description	Construction	Wt	Price	6+
YP5	5' Y Pole for Pinning & Restraining	Aluminum Tube	3 lbs	\$75.00	\$67.50
YP4	4' Y Pole for Pinning & Restraining	Aluminum Tube	2 lbs	\$70.00	\$63.00
YP3	3' Y Pole for Pinning & Restraining	Aluminum Tube	2 lbs	\$65.00	\$58.50
YPC	Y Pole Conversion Kit - Converts any Standard or Heavy Duty Dura-Flex Net Into Y-Pole	Neoprene Cushions	1lb	\$20.00	\$18.00
YPD	Dura-Flex Net Conversion Kit - Converts any Y-Pole into Standard Dura Flex Net	Nylon net and hoop	3 lbs	\$69.00	\$62.10



Versa Net

Hammock Net

Cage Net

Versa Net for Cats

Heavy duty net for cats and other small animals. Net opens by pushing upward toward the end of the shaft and closes when pulling back. The long opening of the net is great for scooping and holding cats from a distance.

Model	Description	Construction	Wt	Price
AVN-26	Versa Net for Cats	18" x 30" with 1/4" Nylon Mesh Openings	4 lbs	\$149.00
ARN-26	Replacement Net for AVN-26 Versa Net	18" x 30" with 1/4" Nylon Mesh Openings	1 lb	\$29.00

Freeman Hammock Nets

An excellent field net. A flexible hoop allows the net head to bent against hard surfaces easing the capture process and reducing escape. This net features tough yet stretchable nylon netting. Small mesh gives more comfort and reduces animal injuries. A quick cord closure with nylon cord lock secures the animal safely within the netting.

Model	Description	Construction	Wt	Price
FP-24H	Freeman Hammock Net 2' - 4' Extendable	17" x 20" with 1/4" Nylon Mesh Openings	4 lbs	\$123.75
FP-36H	Freeman Hammock Net 3' - 6' Extendable	17" x 20" with 1/4" Nylon Mesh Openings	4 lbs	\$133.20
FP-HRN	Replacement Net for FP-24H and FP-36H Hammock Net	17" x 20" with 1/4" Nylon Mesh Openings	1 lb	\$49.20

Freeman Cage Net

Featuring a deep, soft fine-meshed net and a hoop that opens and closes by a slide on the handle. The net has a unique hoop shape to help fit into cage corners. Simple to use, gentle on the animal. Ideal for handling cats, snakes and other wildlife under 25 lbs. The net also features a zipper on the bottom to make release of the animal or examinations easier.

Model	Description	Construction	Wt	Price
FP-CC	Freeman Cage Net	12" x 38" with 1/4" Nylon Mesh Openings	2.5 lbs	\$107.65
FP-CCRC	Replacement Cable for FP-CC	Steel Cable	1 lb	\$16.50
FP-CCRN	Replacement Net for FP-CC	12" x 38" with 1/4" Nylon Mesh Openings	1 lb	\$35.35

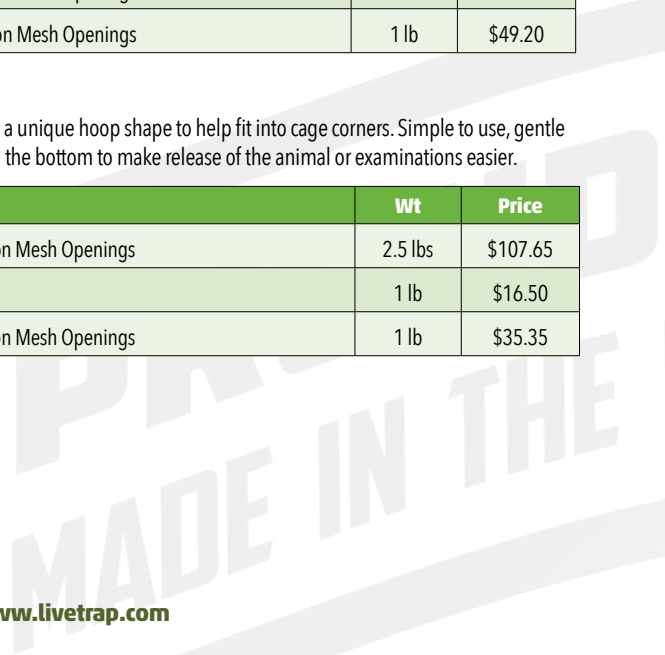

Sometimes, netting an animal may be the only solution to capture it. We offer several sizes of nets that work successfully on a wide range of animals.

Model 3350 - Mighty Net is great for animals up to 50 lbs. It works well on cats, large birds, waterfowl, wildlife, and small to medium sized dogs. The hoop opening is 34" x 40" and the tangle free net is 48" deep with 1 3/4" mesh openings. The handle telescopes from 65" to 96".

Model 3543 - Extension Net is perfect for a wide variety of smaller animals, from bats and chipmunks, to cats and small dogs. Its D-shaped hoop has an opening of 19" x 17". Its telescoping handle reaches from 6 to 18 feet. Its soft honeycombed black tangle-free mesh provides the best design for restraining animals, and it measures 20" deep with 1/4" mesh openings.

Model 3421 - Mini Net is intended for animals up to 25 lbs. It has a hoop opening of 21" x 25". Its telescoping handle reaches from 2' to 4'. Its tangle free, nylon net is 36" deep with 1" mesh openings.

Pole Draw Nets - These nets completely collapse within the handle for easy storage. The net opens by pushing up on the handle slide and locks into place while in use. Intended for animals up to 25 lbs. such as cats, small dogs and birds.



Miscellaneous Nets

Model	Description	Hoop size	Wt	Price
3350	Mighty Net	34" x 40" with 1 3/4" Nylon Mesh Openings	4.3 lbs	\$135.25
3350R	Mighty Replacement Net	34" x 40" with 1 3/4" Nylon Mesh Openings	1.2 lbs	\$40.25
3421	Mini Net	22" x 25" with 1" Nylon Mesh Openings	1.7 lbs	\$90.21
3543	Extension Net	19" x 17" with 1/4" Nylon Mesh Openings	3.5 lbs	\$64.00
3543R	Extension Replacement Net	19" x 17" with 1/4" Nylon Mesh Openings	.2 lbs	\$ 35.00
3601	18" Pole draw net with 40" handle.	15" x 18" with 1" Nylon Mesh Openings	3 lbs	\$69.50
3600	23" Pole draw net with 52" handle	22" x 23" with 1" Nylon Mesh Openings	4 lbs	\$74.50
3602	29" pole draw net with 72" handle	28" x 19" with 1" Nylon Mesh Openings	5 lbs	\$99.50



QN100 - hoop size measures 15" x 14", the net is 19" long, and the handle extends from 19" to 28".

QN101 - hoop size measures 23" x 17", the net is 24" long, and the handle extends from 25" to 40".

FN-LXX - Sturdy metal frame for animals up to 20lbs. The triangular net opening is ideal for use on corners or walls. Drawstring closes and locks the net for secure capture. Handle extends for a total length of 4'. Net has an opening of 18" x 16" and is 34" deep. A great net for bats but sturdy enough for cats and other small mammals.

Quick Draw Collapsible Nets

Model	Description	Hoop size	Wt	Price
QN100	Quick Draw Collapsible Net - Small	15" x 14" with 1/4" Nylon Mesh Openings	1 lb	\$29.99
QN101	Quick Draw Collapsible Net - Medium	23" x 17" with 1/4" Nylon Mesh Openings	1.3 lbs	\$34.99
FN-LXX	Folding Metal Frame Extendable Net	18" x 16" with 1/4" Nylon Mesh Openings	2 lbs	\$107.50
FN-LXXRN	Replacement Net for FN-LXX	18" x 16" with 1/4" Nylon Mesh Openings	1 lb	\$35.20



Throw nets are great to use when getting close to the animal is almost impossible, and conventional nets are out of the question. We offer high quality nylon throw nets with weighted perimeters. This makes them easy to throw and with great accuracy, just throw it like a Frisbee over the top of the animal. We offer several sizes.

TN4 - 4' Throw Net, is great for cats, small dogs, and similar sized animals. It is 4 feet in diameter with 1" nylon mesh openings.

TN6 - 6' Throw Net, is great for small to medium sized dogs and similar sized animals. It is 6 feet in diameter with 2" nylon mesh openings.

TN8 - 8' Throw Net, is great for medium to large size dogs and similar sized animals. It is 8 feet in diameter with 4" nylon mesh openings.

Throw Nets

Model	Description	Construction	Wt	Price
TN4	4' Throw Net	4' Diameter with 1" Nylon Mesh Openings	1.4 lbs	\$93.49
TN6	6' Throw Net	6' Diameter with 2" Nylon Mesh Openings	3.3 lbs	\$106.14
TN8	8' Throw Net	8' Diameter with 4" Nylon Mesh Openings	4.3 lbs	\$118.79

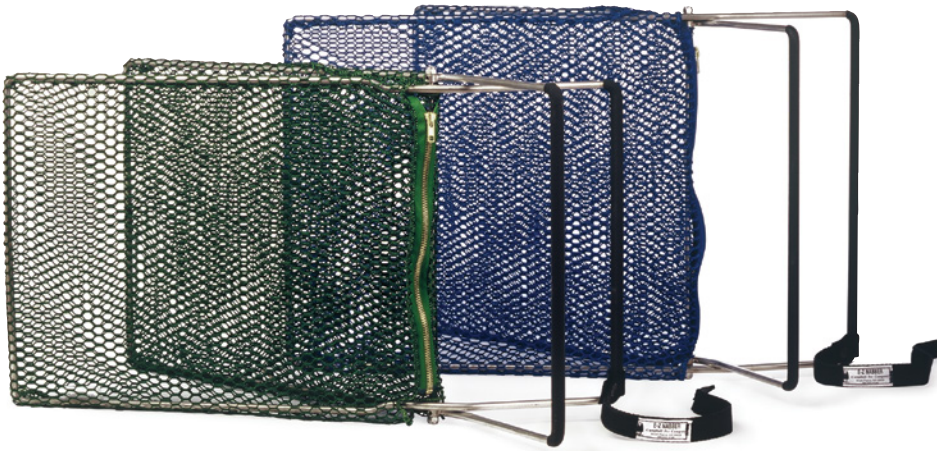

Ensuring safety for animal handlers, saving incredible amounts of time, and providing dozens of uses, the EZ Nabber is a very smart and sound investment. In addition to providing a safe and humane way to capture animals, injections can be given through the net. Pets can be transferred from one cage to another without injury or stress to the animal or the practice staff. Pets can be removed from and/or placed in pet carriers. When the net becomes soiled, leave it on the frame and wash it in the tub with soap and water: use a disinfectant if needed. Abscesses and wounds can be flushed, and the pet can be bathed in the net. Our new 14" frame fits 18" x 18" cages.

EZ-Nabbers

Model	Description	Construction	Price
2600	EZ Nabber 16" Frame	1/4" Nylon Mesh Openings with Stainless Steel Frame	\$135.00
2600-S	EZ Nabber 14" Frame	1/4" Nylon Mesh Openings with Stainless Steel Frame	\$135.00
2601	16" Replacement Net	1/4" Nylon Mesh Openings	\$25.00
2601-S	14" Replacement Net	1/4" Nylon Mesh Openings	\$25.00





Snappy Snare

Super Snare

Snappy Snares

Snappy Snares are practical, affordable and very popular. They offer the quickest and most gentle way to catch pets and they greatly reduce the risk of being bitten and scratched.

Model	Size	Wt	Price	6+
SN30	30" Snappy Snare	.3 lb	\$30.00	\$28.00
SN49	49" Snappy Snare	.6 lb	\$30.00	\$28.00
SN65	65" Snappy Snare	.7 lb	\$32.00	\$30.00
SS49	49" Stainless Snappy Snare	.6 lb	\$75.00	\$72.00
SS65	65" Stainless Snappy Snare	.7 lb	\$78.00	\$75.00

Super Snare

Model	Size	Wt	Price	6+
FSS-1	Super Snare	4 lbs	\$74.30	\$66.87

Quick Leads - Heavy duty quick capture lead made from vinyl coated stainless steel cable. Ideal for quickly capturing large dogs or moving them from one area to another.

Flat Poly Leashes - 1/2" wide x 56" long poly leash with a nickel plated "D" ring. This leash promotes safe transport, is stronger, wider, and thicker than most of our competitors, yet is still very economical. Sold in packs of 50.

Ski Rope Leashes - Round 1/4" x 56" polypro "ski rope" with a solid nickel plated "O" ring. This leash is excellent for in-house use, or to give to those clients who forget to bring a leash. It is machine stitched at both ends for added security. Sold in packs of 25

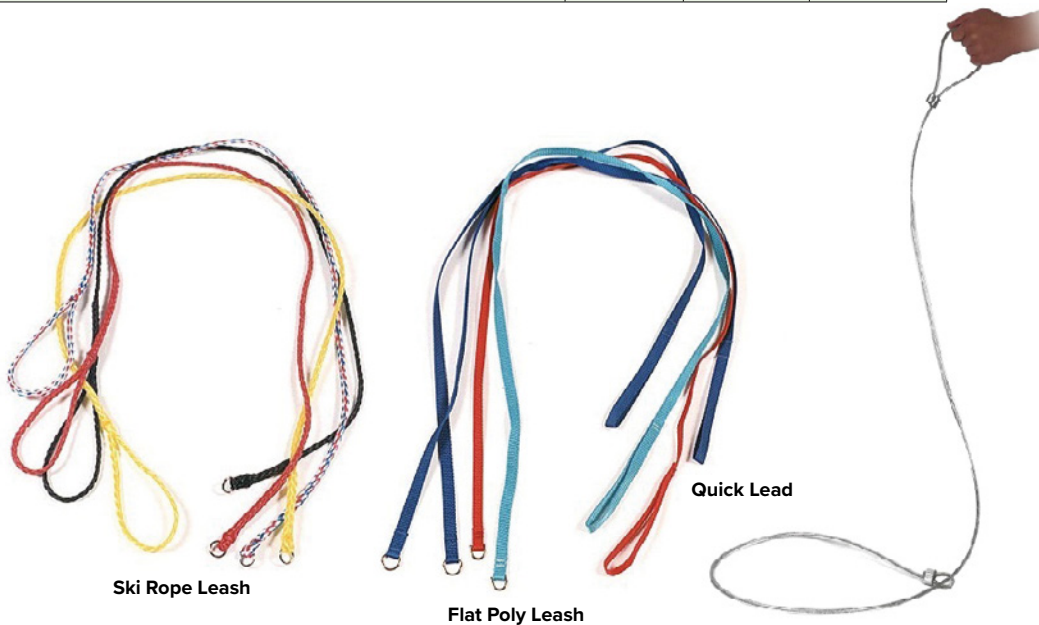

Ski Rope Leash

Flat Poly Leash

Quick Lead

Quick Leads

Model	Size	Wt	Price	6+
QL4	4' Vinyl Coated Steel Cable	1 lb	\$7.50	\$6.75
QL5	5' Vinyl Coated Steel Cable	1 lb	\$8.00	\$7.20
QL6	6' Vinyl Coated Steel Cable	1 lb	\$8.50	\$7.65

Leashes

Model	Size	Wt	Price
SR	25 Pack - Ski Rope 1/4" x 56" Leash	5 lbs	\$23.75
FP	50 Pack - Flat Poly 1/2" x 56" Leash	10 lbs	\$34.50

Tomahawk Animal Control Poles provide handlers with great versatility to restrain or rescue a wide variety of animals. All of our control poles feature non-slip grips, automatic locking mechanism, spring loaded noose, protective bite guard, quick noose release knob, vinyl coated noose, and a 360 degree kink resistant swivel head. Extension poles have the added benefit of expanding when additional length is needed and retracting for storage and heavy duty use.

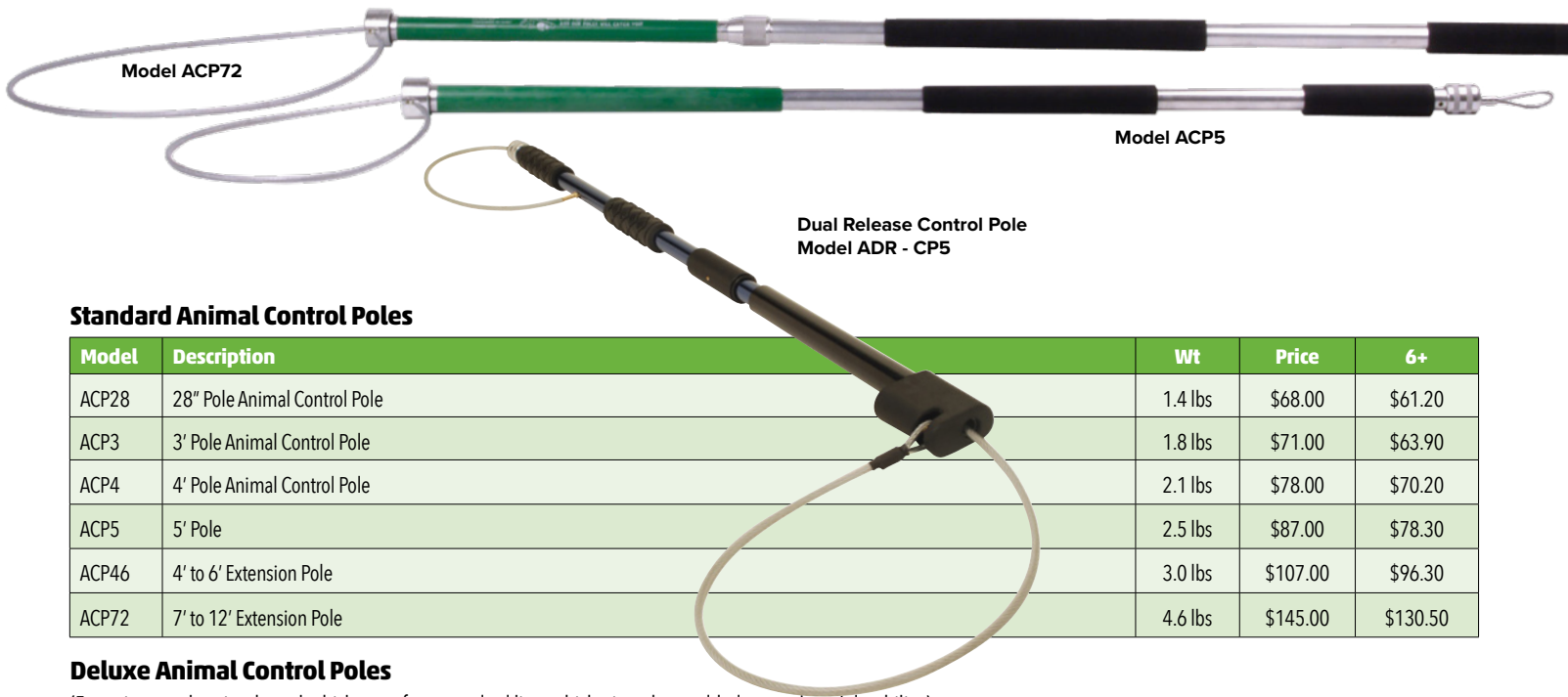

Standard Animal Control Poles

Model	Description	Wt	Price	6+
ACP28	28" Pole Animal Control Pole	1.4 lbs	\$68.00	\$61.20
ACP3	3' Pole Animal Control Pole	1.8 lbs	\$71.00	\$63.90
ACP4	4' Pole Animal Control Pole	2.1 lbs	\$78.00	\$70.20
ACP5	5' Pole	2.5 lbs	\$87.00	\$78.30
ACP46	4' to 6' Extension Pole	3.0 lbs	\$107.00	\$96.30
ACP72	7' to 12' Extension Pole	4.6 lbs	\$145.00	\$130.50

Deluxe Animal Control Poles

(Featuring nearly twice the pole thickness of our standard line, which gives them added strength and durability.)

Model	Description	Wt	Price	6+
DACP3	3' Deluxe Animal Control Pole	2.0 lbs	\$79.50	\$71.55
DACP4	4' Deluxe Animal Control Pole	2.3 lbs	\$89.50	\$80.50
DACP5	5' Deluxe Animal Control Pole	2.7 lbs	\$99.50	\$89.55

Stainless Steel Animal Control Poles

Model	Description	Wt	Price	6+
SS4	4' Stainless Steel Pole	3.4 lbs	\$105.00	\$94.50
SS5	5' Stainless Steel Pole	4.1 lbs	\$110.00	\$99.00

Dual Release Control Poles

Featuring a slide control which instantly drops the noose from the pole to release the animal. The noose is also spring loaded to allow handlers to extend the cable through the pole to release the animal. The choice is yours!

Model	Description	Wt	Price
ADR-CP3	3' Dual Release Catch Pole	2.5 lbs	\$83.95
ADR-CP4	4' Dual Release Catch Pole	3 lbs	\$92.00
ADR-CP5	5' Dual Release Catch Pole	3.5 lbs	\$99.75

REPLACEMENT PARTS AVAILABLE FOR ALL ANIMAL CONTROL POLES.

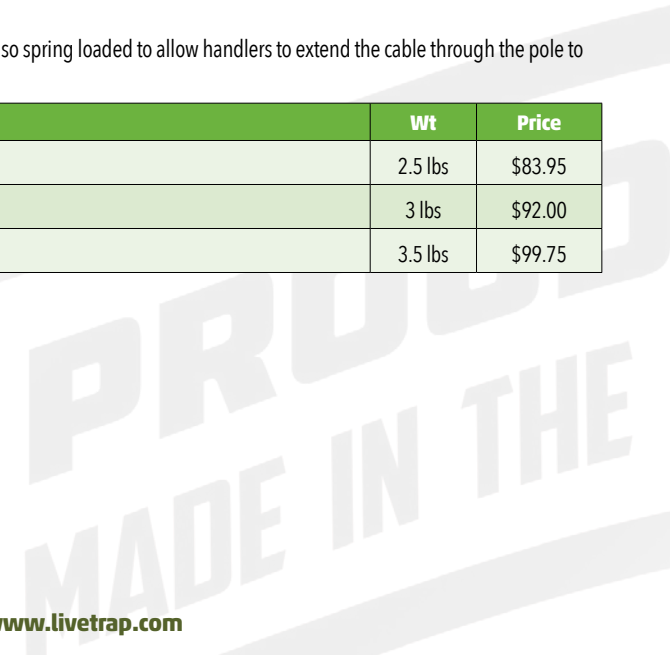

Animal Graspers are essential tools for handling cats and wildlife. They provide a safe way to reach animals who have hid in smaller areas. The smoothly contoured grasper jaws are designed to restrain animals and pull them out of hard to reach areas while minimizing discomfort. The handle grip commands a steel cable, which activates the jaws. This provides the handler with a precise feel of pressure being applied to the animal.

Tomahawk offers graspers in three different categories and two standard lengths. We also custom build graspers to any desired length. Please call for quotes on custom lengths

Standard Graspers Feature:

- Heavy-duty cast aluminum grasping end with two gripping jaws.
- Heavy-duty cast aluminum handle and lever.
- Stainless steel aircraft cable to connect lever to grasper end.
- Anodized aluminum tube.
- Cushioned grasper jaws for less stress to the animal

Heavy Duty Graspers Feature:

- Same features as our standard tube except with super strong .090 aluminum tube.

Nylon Graspers Feature:

- Same features as our standard tube except with nylon jaws and handle. Nylon is extremely lightweight yet strong and durable.

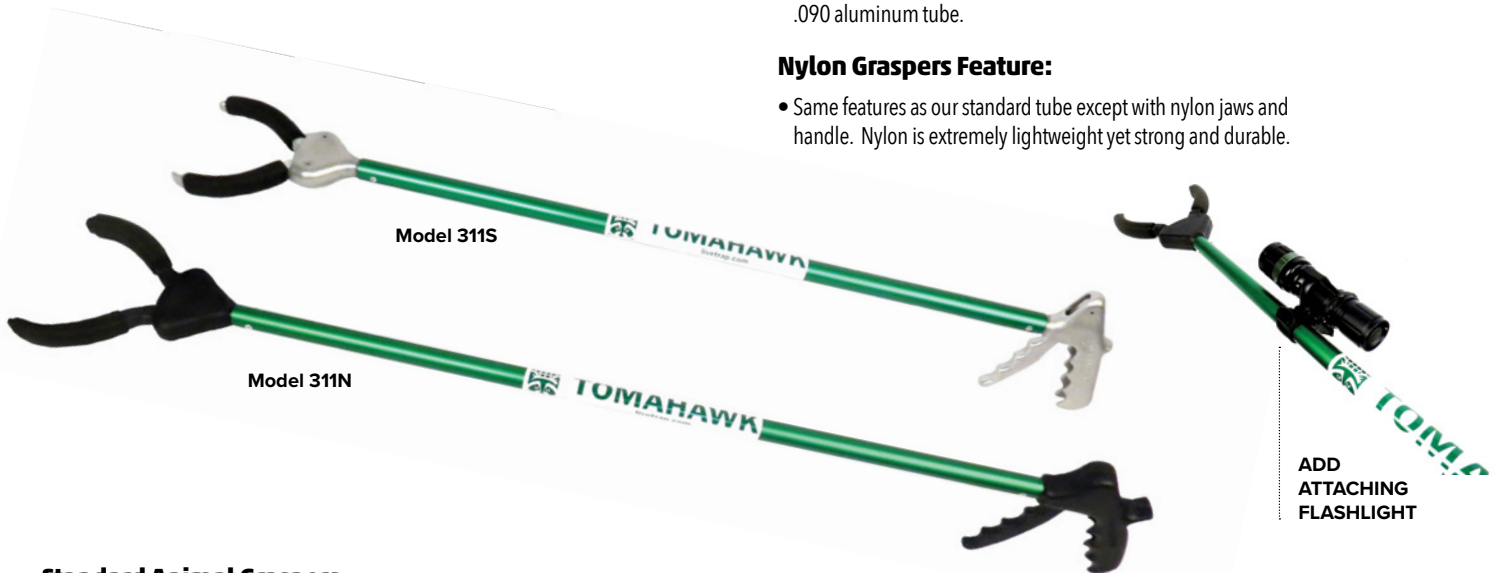

Standard Animal Graspers

Model	Description	Construction	Wt	Price	6+
310	28" Grasper - Includes Jaw Cushions	Aluminum	2 lbs	\$69.95	\$62.96
311	38" Grasper - Includes Jaw Cushions	Aluminum	2 lbs	\$69.95	\$62.96

Heavy Duty Animal Graspers

Model	Description	Construction	Wt	Price	6+
310S	28" HD Grasper, Super Tube - Includes Jaw Cushions	Aluminum	2 lbs	\$79.95	\$71.96
311S	38" HD Grasper, Super Tube - Includes Jaw Cushions	Aluminum	2 lbs	\$79.95	\$71.96

Nylon Animal Graspers

Model	Description	Construction	Wt	Price	6+
310N	28" Nylon Grasper	Nylon, Aluminum	1 lb	\$59.95	\$53.96
311N	38" Nylon Grasper	Nylon, Aluminum	1 lb	\$59.95	\$53.96

Animal Grasper Accessories

Model	Description	Wt	Price	6+
FL100-F	LED Flashlight for Snake Tong / Animal Grasper	6 oz.	\$14.95	\$13.46
FL100-H	Flashlight Holder Attachment for Tong or Grasper	3 oz.	\$4.95	\$4.46
FL100-C	LED Flashlight and Flashlight Holder Combo	9 oz.	\$17.50	\$15.75
GRC	Pair of Replacement Jaw Cushions for All Graspers	3 oz	\$9.95	\$8.96

CUSTOM LENGTHS AVAILABLE FOR ALL STYLES UPON REQUEST – CALL OR EMAIL FOR QUOTE

Model PSP32 is our Professional Syringe Pole for 3cc or 1cc syringes. It features a needle guard and aluminum syringe jacket. Simply drop your syringe into the syringe jacket and screw the jacket to the pole. When ready press the thumb operated plunger to inject. After injection, simply remove the spent syringe and throw it away. The syringe pole will fit through wire mesh as small as 1x1" for use in traps or cages.

Thumb Trigger Syringe Poles operate just like syringes at the doctor's office but with a much greater reach. They are available in 3cc and 12cc sizes and a variety of lengths. These syringe poles require a syringe to be taken apart, and screwed on to the end.

Push To Inject Syringe Poles also known as jab sticks require you to push into the animal to inject. We offer a variety of push to inject syringe poles in both 3cc and 12cc sizes including a 42"-99" extendable and attachment ends for broomstick handles. These syringe poles also require the syringe to be taken apart and pushed on to the end of the pole.



Professional Thumb Trigger Syringe Poles For 1cc and 3c

Model	Description	Wt	Price
PSP32	Professional Thumb Operated Syringe Pole with Needle Guard for 1cc and 3cc Syringes	1 lbs	\$89.00

Thumb Trigger Syringe Poles For 3cc

Model	Description	Construction	Wt	Price
TSP15-3	15" - 3cc Syringe Pole	Anodized Steel Tube & Rod	1 lbs	\$89.00
TSP33-3	33" - 3cc Syringe Pole	Anodized Steel Tube & Rod	1.5 lbs	\$89.00
TSP54-3	54" - 3cc Syringe Pole	Anodized Steel Tube & Rod	2 lbs	\$89.00

Thumb Trigger Syringe Poles for 12cc

Model	Description	Construction	Wt	Price
TSP19-12	19" - 12cc Syringe Pole	Anodized Steel Tube & Rod	1 lbs	\$89.00
TSP37-12	37" - 12cc Syringe Pole	Anodized Steel Tube & Rod	1.5 lbs	\$89.00
TSP47-12	47" - 12cc Syringe Pole	Anodized Steel Tube & Rod	2 lbs	\$89.00

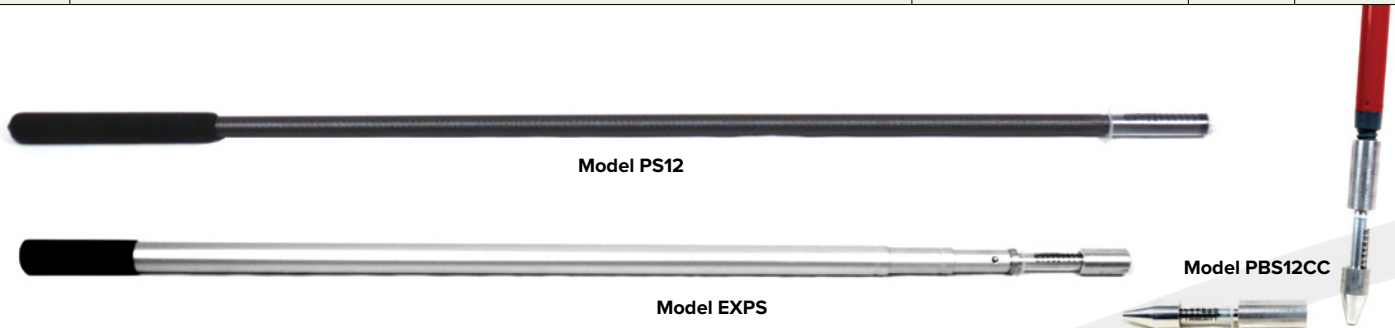

Push Syringe Poles / Jab Sticks

Model	Description	Construction	Wt	Price
PS03	36" 3cc Jab Stick	Plastic	2 lbs	\$39.50
PS12	36" 12cc Jab Stick	Plastic	2 lbs	\$39.50
TP03	16" 3cc Jab Stick	Plastic	1 lbs	\$29.50
TP12	16" 12cc Jab Stick	Plastic	1 lbs	\$29.50
EXPS	42" to 99" Telescoping Jab Stick	Aluminum Tube	5 lbs	\$79.50
PBS3CC	3cc jab stick attachment for standard broom handles.	Aluminum	1 lbs	\$60.00
PBS12CC	3cc jab stick attachment for standard broom handles.	Aluminum	1 lbs	\$60.00



BGD - Bite Guard Deluxe

Designed to allow for very good dexterity and feel with good crushing protection. Made with 18" top-grain cowhide with Kevlar lining There is additional padding in the sleeves which makes these gloves excellent for aggressive animals.

BGL - 18" Bite Guard Glove

These gloves provide excellent protection against animal bites and scratches. Made with split-grain cowhide with a Kevlar lining, these gloves offer very good crush resistance against bites.

BGP - Bite Guard Premium

These premium quality animal handling gloves are made in the USA and feature a thick Kevlar Felt lining for puncture resistance up past the elbow. Trusted by professionals working with wildlife and domestic animals these gloves are an ideal choice for working with cats, dogs, birds, snakes and wildlife.

TM - Maxima Gloves

Maximum crushing protection. Removable top-grain padded outer layer. Inner layer features elk hide hand for dexterity plus heavily-padded sleeves. Ideal for large, dangerous dogs or other crushing-bite animals as well as raptors and large wildlife.

BEAST18, BEAST22 - BITE BUSTER BEAST GLOVES

All in one utility glove with a double layer of Kevlar and synthetic puncture resistant polymers. Designed for handling animals with great dexterity, puncture resistance, and crushing protection. Contains no animal skins.

CG - Critter Gloves

Critter gloves have been designed to give you added protection without compromising dexterity when handling animals. These gloves are made from Elk-hide and lined with Kevlar. The gauntlet is made from Cordura and lined with a special knit Kevlar. Resists sharp teeth, talons, and scratches. Covers past the elbow. Excellent for cats, birds and small mammals.

Model	Description	Glove Hand Construction	Glove Sleeve Construction	Price
BGL	Bite Guard Long - 18" (S-M-L)	Split-grain Cowhide with Kevlar Lining	Heavily Padded Split Grain with Kevlar Lining	\$79.95
BGD	Bite Guard Deluxe - 18" (S-M-L)	Top Grain Leather with Kevlar Lining	Heavily Padded Split Grain with Kevlar Lining	\$89.95
BGP	Bite Guard Premium (S/M, L/XL)	Top Grain Leather with Kevlar Felt	Split Grain Leather with Kevlar Felt	\$129.00
CG	Gritter Gloves (S,M,L,XL)	Elk-hide with Kevlar Lining	Cordura with Kevlar Lining	\$91.30
TM	Maxima Gloves (M-L-XL)	Elk-hide with Removable Top Grain Outer	Heavily Padded Split Grain	\$194.25
BEAST18	Bite Buster Beast - 18" (S/M - L/XL)	Synthetic Materials - No Animal Skins	Double Kevlar Layer & Puncture Resistant Polymers	\$135.00
BEAST22	Bite Buster Beast - 22" (S/M - L/XL)	Synthetic Materials - No Animal Skins	Double Kevlar Layer & Puncture Resistant Polymers	\$145.00



AGK - Animal Gauntlet Gloves

These gloves offer great penetration resistance with good dexterity. Kevlar-lined elk hide hand. Long or extra-long Kevlar-lined elk hide sleeve. A perfect cat and bird glove and excellent for small mammals. 18" Gauntlet covers forearm. 23" Gauntlet covers above elbow.

ARMH - ArmOrHand Gloves

These gloves are made of all synthetic material and offer hand and arm coverage up to the elbow with excellent dexterity making these excellent gloves for scuffing cats. Reinforced high-injury areas provide additional protection. The outer layer is made of durable stretch Cordura and hands are lined with double stitched Kevlar. Palms and fingertips feature textured patches for non-slip grip.

ARMHFIN - ArmOrHand Procedure Gloves

These gloves have all the same features as model ARMH listed above but also feature an exposed thumb, pointer and middle finger for performing fine motor skills.

RG - Rabies Gloves

These gloves feature an elk hide hand, lined with Kevlar, and a double layer of leather extending over the back of the hand for bite protection. Heavily padded gauntlets extend to elbow for full forearm protection. Offers high manipulability with full protection throughout.

VP03 - VET-PRO MAGNUM GLOVES

Provide superior puncture resistance and crushing protection with 400 stainless steel safety bars built into the hand, clinched on the back and front of the fingers, to disperse force and shield against penetration. Initially developed for handling primates, these gloves offer the greatest bite protection while still maintaining an ample amount of dexterity.

VP04 - VET-PRO WARDEN GLOVES

Features a ballistic lining of DuPont Kevlar felt. Unlike knitted or woven versions, Kevlar felt is tightly packed for maximum puncture resistance. Double stitched with Kevlar thread, with a loose fit for dexterity and emergency removal. Developed for the safe and gentle handling of dogs, cats, snakes, and small wild animals. 23" inches overall hand and cuff.

VP05 - VET-PRO WARDEN PRO-MAX GLOVES

Developed for use with feral cats, snakes, dogs, reptiles, and other animals. Double lined thick Kevlar felt in the hand and cuff portion.

Model	Description	Glove Hand Construction	Glove Sleeve Construction	Price
AGK	Animal Gauntlet 18" (S-M-L)	Kevlar-lined Elkhide Hand	Kevlar-lined Elkhide Sleeve	\$104.95
AGKL	Animal Gauntlet 23" (S-M-L)	Kevlar-lined Elkhide Hand	Kevlar-lined Elkhide Sleeve	\$111.25
ARMHFIN	Armor Hand Gloves with Open Fingers (S-M-L-XL)	Kevlar-lined Cordura	Cordura	\$150.00
ARMH	Armor Hand Gloves (S-M-L-XL)	Kevlar-lined Cordura	Cordura	\$150.00
RG	Rabies Gloves (S-M-L-XL)	Elkhide Hand, Lined with Kevlar	Heavily Padded Sleeves	\$89.20
VP04	Vet-Pro Warden Gloves (S/M, L/XL)	Leather & Thick Kevlar Felt Lining	Split Grain Leather & Thick Kevlar Felt	\$109.95
VP05	Vet-Pro Warden Pro-Max - (L)	Leather & Double Thick Kevlar Felt Lining	Split Grain Leather & Thick Kevlar Felt	\$134.95
VP03	Vet-Pro Magnum Gloves - (L)	Leather with Stainless Steel & Thick Kevlar Felt Lining	Split Grain Leather & Thick Kevlar Felt	\$164.95

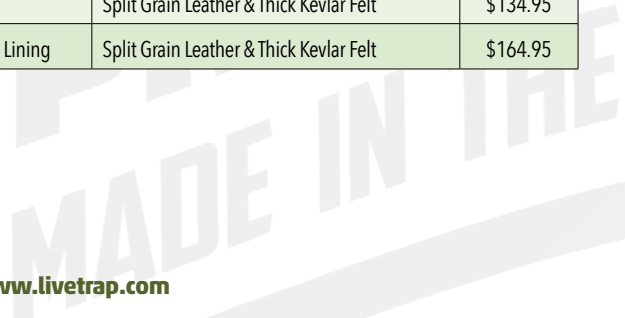



 **FREE SHIPPING
ON ALL BAITS**

Paste Baits

Model	Description	Target Animals	Wt	Price	6+
NWS001	Beaver Blaster - 4 oz	Beaver	4 oz	\$25.00	\$22.50
VL2OZ	Very Berry Loganberry - 2 oz	Raccoon	2 oz	\$6.95	\$4.00
SF2OZ	Shellfish - 2 oz	Cats, Raccoon, Skunk	2 oz	\$6.95	\$4.00
AP	Apple - 6 oz	All Animals	6 oz	\$9.95	\$5.50
BA	Banana - 6 oz	Skunk, Raccoon	6 oz	\$9.95	\$5.50
BTH	Big Time Honey - 6 oz	Skunk, Raccoon	6 oz	\$9.95	\$5.50
CH	Chuckster	Groundhog/Woodchuck	6 oz	\$9.95	\$5.50
FR	Fruit Punch - 6 oz	Raccoon, Fox, Skunk, Opossum	6 oz	\$9.95	\$5.50
GS	Golden Maze Sweetcorn - 6 oz	Skunks, Raccoon	6 oz	\$9.95	\$5.50
NB	NB Squirrel Paste - 8 oz	Squirrel, Chipmunk and Other Rodents	8 oz	\$9.95	\$5.50
SA	Sweet Tooth Apple Cinnamon - 6 oz	Raccoon, Skunk	6 oz	\$9.95	\$5.50
SF	Shellfish - 6 oz	Cats, Dog, Raccoon, Skunk, Opossum	6 oz	\$9.95	\$5.50
SP	Squirrel Paste (Nutty) - 8 oz	Squirrel, Chipmunks and Other Rodents	6 oz	\$9.95	\$5.50
STR	Strawberry - 6 oz	Skunks, Raccoon, Opossum, Fox	6 oz	\$9.95	\$5.50
TP	Tuti Fruit Persimmon - 6 oz	Raccoon, Skunk, Fox, Opossum	6 oz	\$9.95	\$5.50
VL	Very Berry Loganberry - 6 oz	Raccoon	6 oz	\$9.95	\$5.50
SB	Coon SB 6oz	Raccoon	6 oz	\$9.95	\$5.50
WCSTJRR-4	Canine Bait	Dogs, Fox, Coyote	4 oz	\$20.00	\$15.00
BS12	One Dozen Bait Sticks	Holds Paste & Liquid Baits from Top of Trap	8 oz.	\$8.50	\$7.65



Liquid Attractants & Repellents

Model	Description	Target Animals	Wt	Price	6+
LQCH	Attractant - Liquid Chuckster - 1 oz	Woodchuck/Groundhog	1 oz	\$7.50	\$6.75
LQPN	Attractant - Liquid Peanuts - 2oz	Squirrel, Chipmunk and Other Rodents	2 oz	\$9.95	\$8.96
EVICT	Raccoon Eviction Repellent	Raccoon	1oz	\$19.95	\$17.96

Snake Lure

Strike-Um Snake Lure is designed to attract snakes to snake traps. Squeeze a few drops onto a cotton ball and place inside the trap. When your target snakes are ready to feed they will follow the scent into the trap.

Model	Description	Size	Wt	Price	6+
WCSTJSL	Strike-Um Liquid Snake Lure	4 Oz. Bottle	4 oz.	\$18.95	\$17.06

Bait Equipment

Model	Description	For Use With	Size	Price	6+
BS12	One Dozen Bait Sticks	Plastic Stem & Foam End	4" Long	\$8.50	\$7.65
BB22	Small Hanging Bait Basket with Open Top	1/2 x 1/2 - 14 gauge	2 x 2 x 2	\$5.85	\$5.27
BB23	Medium Hanging Bait Basket with Open Top	1/2 x 1/2 - 14 gauge	2.5 x 2.5 x 3	\$6.35	\$5.72
BB34	Large Hanging Bait Basket with Open Top	1/2 x 1/2 - 14 gauge	3.5 x 3.5 x 4	\$6.90	\$6.21
BBD22	Small Hanging Bait Basket with Cover	1/2 x 1/2 - 14 gauge	2 x 2 x 2	\$7.95	\$7.16
BBD33	Medium Hanging Bait Basket with Cover	1/2 x 1/2 - 14 gauge	2.5 x 2.5 x 3	\$8.50	\$7.65
BBD34	Large Hanging Bait Basket with Cover	1/2 x 1/2 - 14 gauge	3.5 x 3.5 x 4	\$9.00	\$8.10





A8032A-G



A8040



A8050



23221



23305-1GAL



23311-055C



23309-005C



Powerful enough for an outbreak and safe enough for everyday use! Rescue has more than 6 times the cleaning power of other products and works in half the time of traditional disinfectants. Rescue kills bacteria in just 5 minutes vs 10 for traditional disinfectants. Traditional disinfectants usually need to be applied twice in order to keep the surface wet for that long. Traditional disinfectants also require that you wash and rinse the surface prior to using them, and then rinse again after the 10 minute contact time is met!? WHO HAS THE TIME! With Rescue you can disinfect in one single step. Rescue is safe, fast and will not destroy your equipment like other cleaners. It is an ideal product for cleaning traps, cages or any surface that has been touched by animals. It is available in concentrate, and ready to use wipes.

Ogena Solutions Cleaning Products

Model	Description	Price Each
A8334	1 Gallon of Pure Oxygen Ultra Shampoo	\$64.50
23221	160 Pack of Rescue Ready To Use Wipes	\$15.50
23305-1GAL	1 Gallon of Rescue Concentrate	\$35.00
23309-005C	5 Gallon Pail of Rescue Concentrate	\$157.50
23311-055C	55 Gallon Drum of Rescue Concentrate	\$1559.25
A8050	Hand dispensing pump for 1 gallon containers	\$9.00
A8050-AE	Adaptor for A8050 hand pump to use with 5 gallon pails	\$7.50
A8040B-32	Hose Attaching Foamer w/ 32Oz bottle for Rescue Concentrate	\$130.00
A8032A-G	Two Way Ball Valve Mix Station for Rescue Concentrate	\$295.00

Couldn't find it? We can help!

CUSTOM TRAPS AND CAGES

If we don't already make what you are looking for we can make custom traps to fit your needs. We work with government organizations, professionals, wildlife control operators, and rescue groups around the world to develop traps and cages that meet their specific needs. We can customize existing products or start from scratch to make the trap, cage or accessory that will work for your situation. Call us at 800-272-8727 or email trapem@livetrap.com and ask to speak to a custom trap specialist.

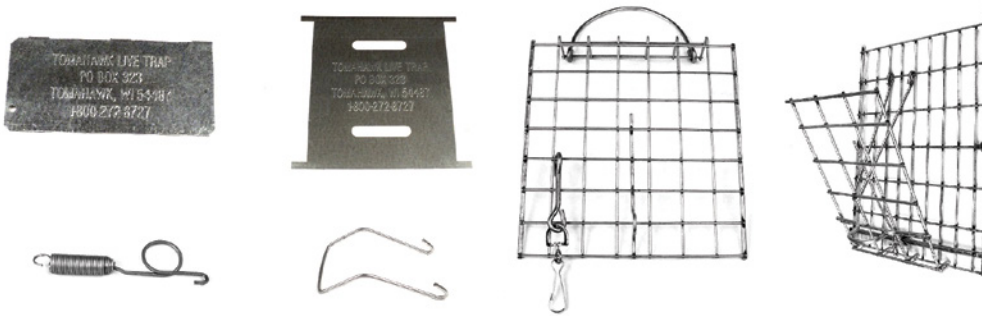

REPLACEMENT PARTS

Should you ever need to replace or add parts to a trap we sell all of the parts we use to make our traps. Everything from trap doors, release doors, trip pans, springs and clips. Every part on your trap can be purchased and replaced. We even offer tools for clips and cutting. Our parts are available on our website categorized by trap model or call us and we can find the part you need.

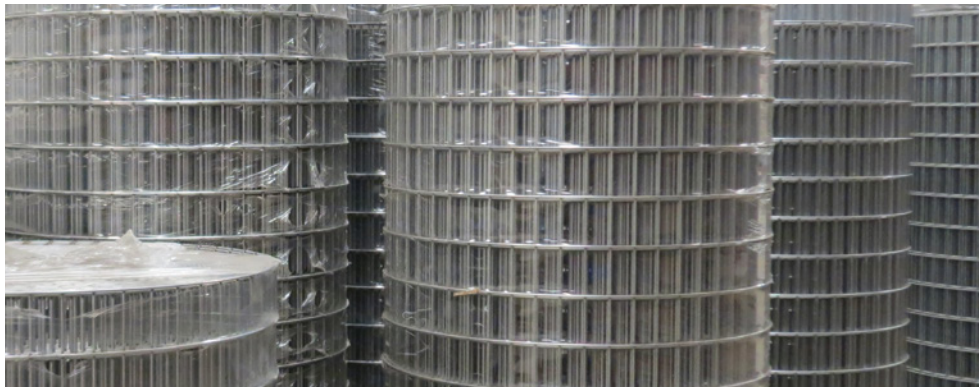

ROLL WIRE

We sell 100' rolls of galvanized wire mesh ranging from 9" tall up to 72" tall. They are available in many different mesh patterns and thicknesses. Please call us at 800-272-8727 or email us at trapem@livetrap.com for prices and availability of sizes and styles.





On behalf of the Tomahawk Live Trap staff,
THANK YOU FOR YOUR ORDER!



Tomahawk llc
L I V E • T R A P

Dependable. Tough. **Tomahawk.**

Call: 800-272-8727 | Online: www.livetrapp.com
PO Box 155, Hazelhurst, WI 54531 • Fax: 715-356-4611 • Email: trapem@livetrapp.com